

4414
PESO TEORICO 0.435 KG/M
PERIMETRO 0.201 MTS

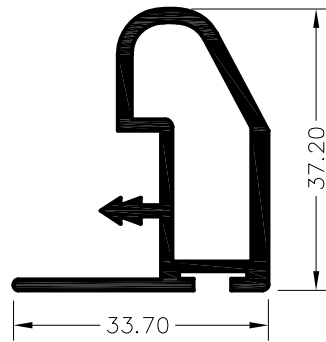

4415
PESO TEORICO 0.602 KG/M
PERIMETRO 0.262 MTS

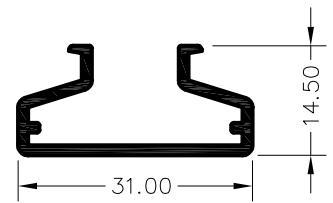

4426
PESO TEORICO 0.259 KG/M
PERIMETRO 0.151 MTS

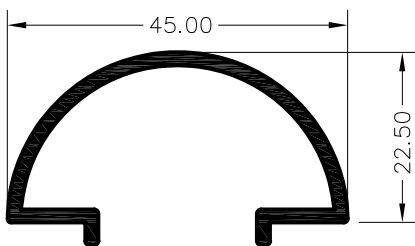

4427
PESO TEORICO 0.432 KG/M
PERIMETRO 0.191 MTS

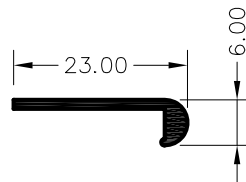

4428
PESO TEORICO 0.103 KG/M
PERIMETRO 0.056 MTS

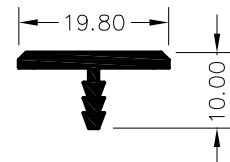

4431
PESO TEORICO 0.143 KG/M
PERIMETRO 0.064 MTS

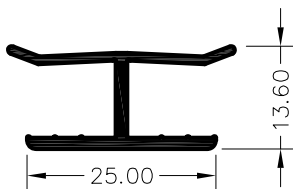

4447
PESO TEORICO 0.224 KG/M
PERIMETRO 0.133 MTS

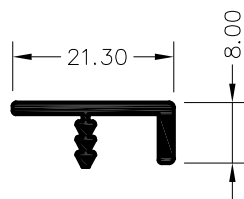

4448
PESO TEORICO 0.151 KG/M
PERIMETRO 0.077 MTS

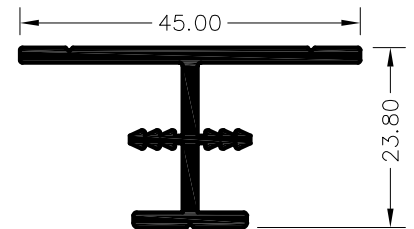

4751
PESO TEORICO 0.494 KG/M
PERIMETRO 0.201 MTS

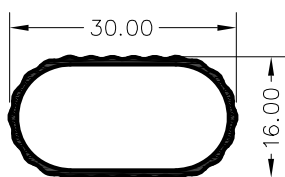

11051
PESO TEORICO 0.173 KG/M
PERIMETRO 0.152 MTS

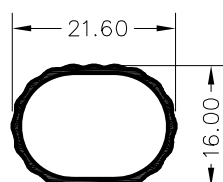

11055
PESO TEORICO 0.132 KG/M
PERIMETRO 0.117 MTS

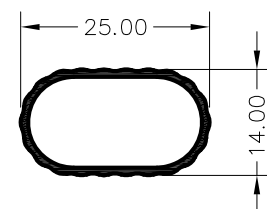

11055
PESO TEORICO 0.148 KG/M
PERIMETRO 0.126 MTS

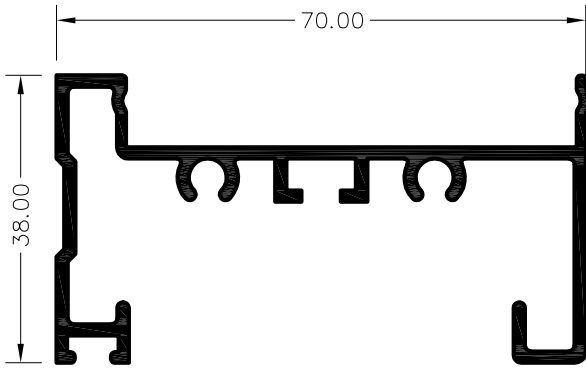

1853
PESO TEORICO 0.888 KG/M
PERIMETRO 0.437 MTS

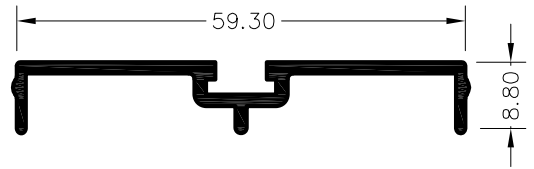

1854
PESO TEORICO 0.356 KG/M
PERIMETRO 0.179 MTS



1855
PESO TEORICO 0.359 KG/M
PERIMETRO 0.180 MTS

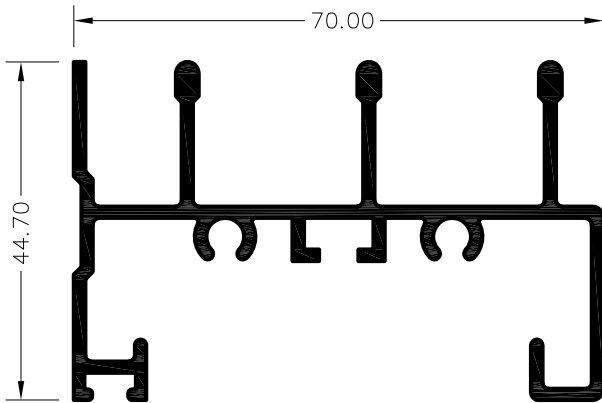

1857
PESO TEORICO 1.123 KG/M
PERIMETRO 0.519 MTS

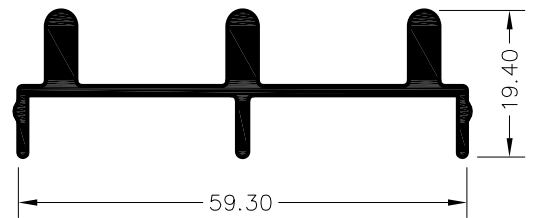

1856
PESO TEORICO 0.594 KG/M
PERIMETRO 0.221 MTS

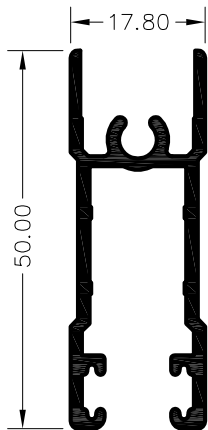

1858
PESO TEORICO 0.559 KG/M
PERIMETRO 0.280 MTS

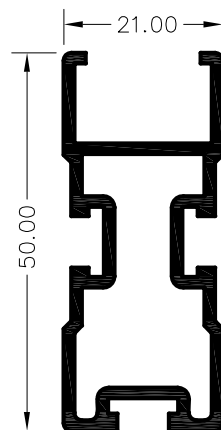

1859
PESO TEORICO 0.670 KG/M
PERIMETRO 0.339 MTS

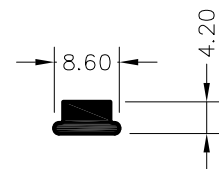

1862
PESO TEORICO 0.078 KG/M
PERIMETRO 0.024 MTS

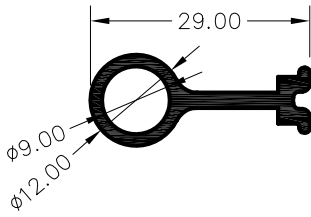

1860
PESO TEORICO 0.270 KG/M
PERIMETRO 0.113 MTS

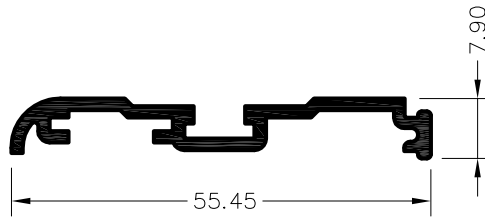

1861
PESO TEORICO 0.365 KG/M
PERIMETRO 0.174 MTS

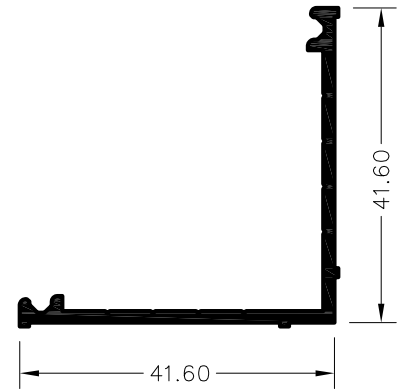

1863
PESO TEORICO 0.362 KG/M
PERIMETRO 0.184 MTS

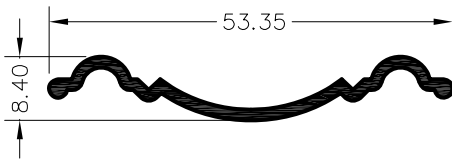

1864
PESO TEORICO 0.243 KG/M
PERIMETRO 0.129 MTS

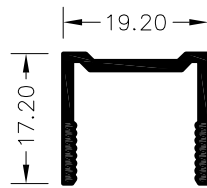

2056
PESO TEORICO 0.178 KG/M
PERIMETRO 0.113 MTS

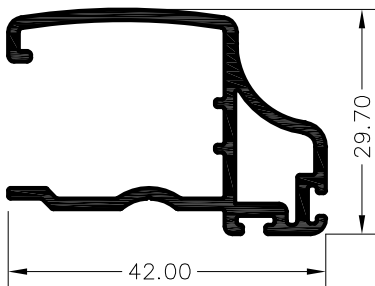

11625
PESO TEORICO 0.537 KG/M
PERIMETRO 0.274 MTS

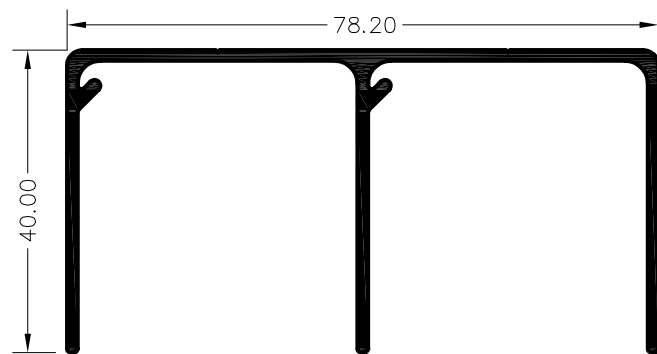

11628
PESO TEORICO 0.780 KG/M
PERIMETRO 0.394 MTS

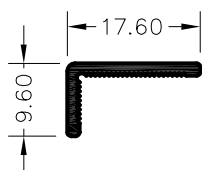

11630
PESO TEORICO 0.099 KG/M
PERIMETRO 0.062 MTS

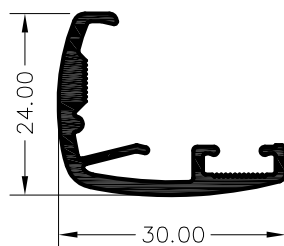

11626
PESO TEORICO 0.333 KG/M
PERIMETRO 0.156 MTS

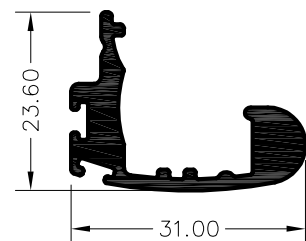

11627
PESO TEORICO 0.480 KG/M
PERIMETRO 0.140 MTS

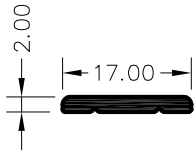

11633
PESO TEORICO 0.089 KG/M
PERIMETRO 0.038 MTS

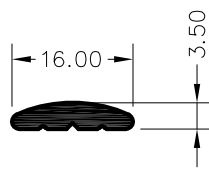

11631
PESO TEORICO 0.121 KG/M
PERIMETRO 0.036 MTS

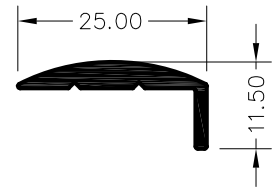

11632
PESO TEORICO 0.199 KG/M
PERIMETRO 0.069 MTS

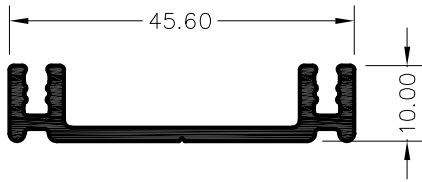

11629
PESO TEORICO 0.396 KG/M
PERIMETRO 0.158 MTS

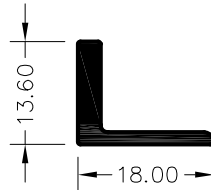

11637
PESO TEORICO 0.174 KG/M
PERIMETRO 0.062 MTS

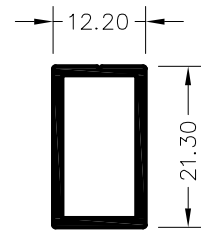

11635
PESO TEORICO 0.202 KG/M
PERIMETRO 0.124 MTS

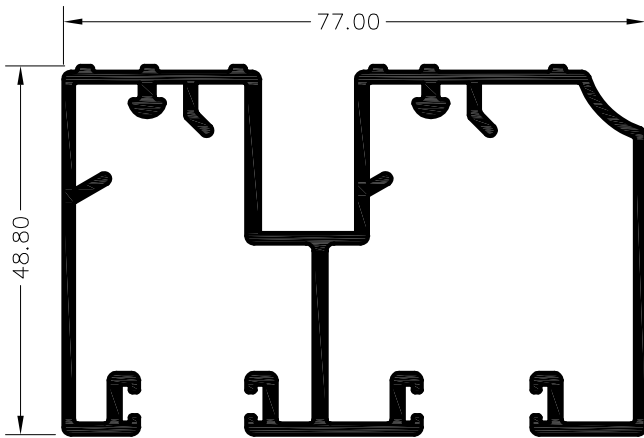

11634
PESO TEORICO 1.489 KG/M
PERIMETRO 0.711 MTS

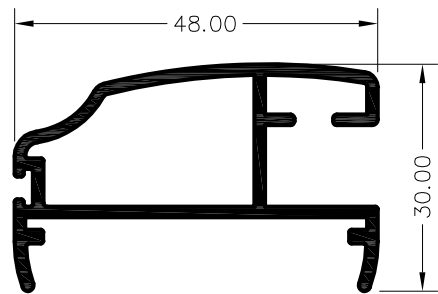

11636
PESO TEORICO 0.632 KG/M
PERIMETRO 0.327 MTS

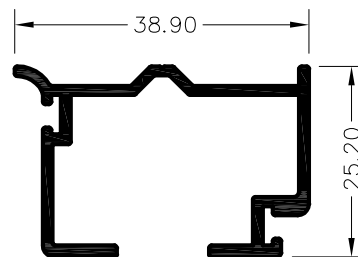

11638
PESO TEORICO 0.414 KG/M
PERIMETRO 0.232 MTS

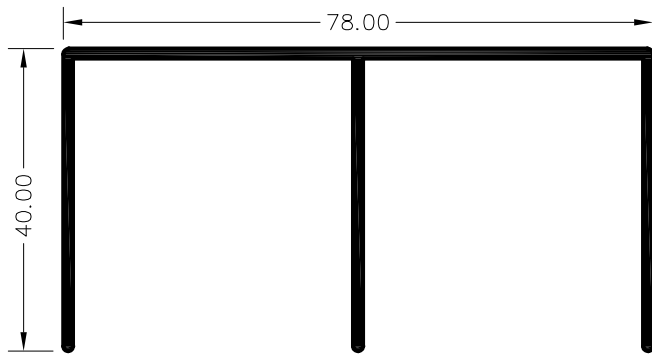

5250
PESO TEORICO 0.680 KG/M
PERIMETRO 0.388 MTS

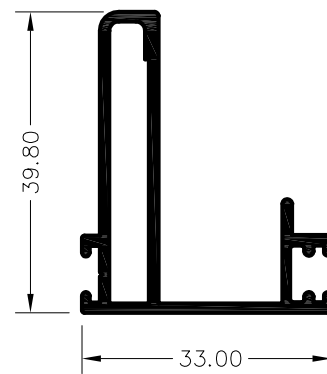

5251
PESO TEORICO 0.487 KG/M
PERIMETRO 0.284 MTS

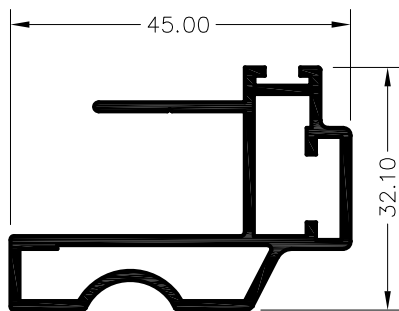

5252
PESO TEORICO 0.593 KG/M
PERIMETRO 0.354 MTS

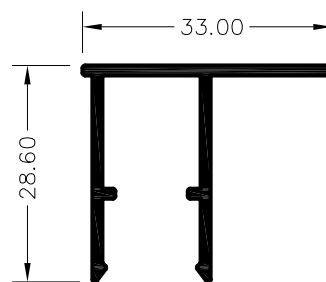

5253
PESO TEORICO 0.318 KG/M
PERIMETRO 0.183 MTS

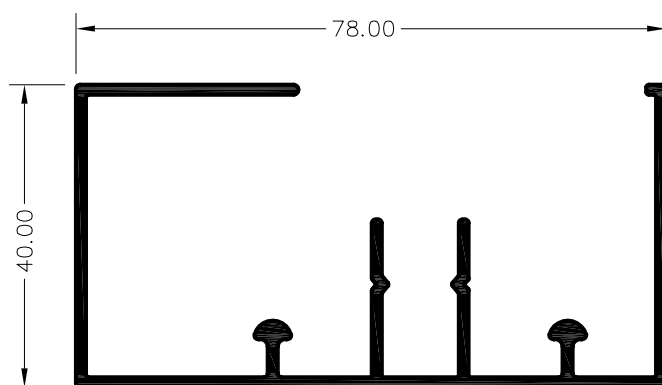

5254
PESO TEORICO 0.887 KG/M
PERIMETRO 0.492 MTS

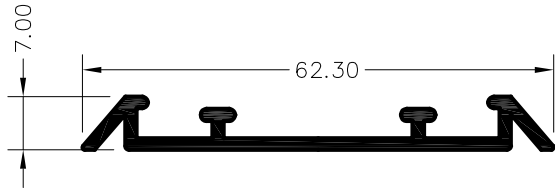

4075
PESO TEORICO 0.379 KG/M
PERIMETRO 0.187 MTS

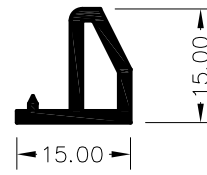

4076
PESO TEORICO 0.181 KG/M
PERIMETRO 0.091 MTS

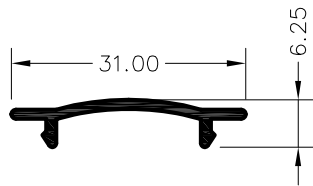

4077
PESO TEORICO 0.127 KG/M
PERIMETRO 0.078 MTS

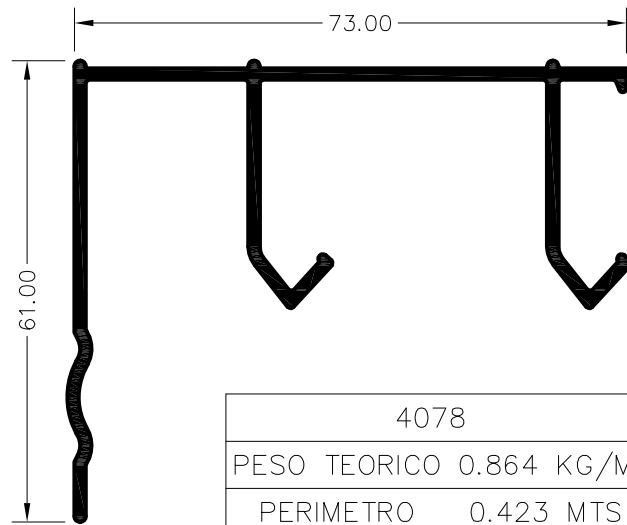

4078
PESO TEORICO 0.864 KG/M
PERIMETRO 0.423 MTS

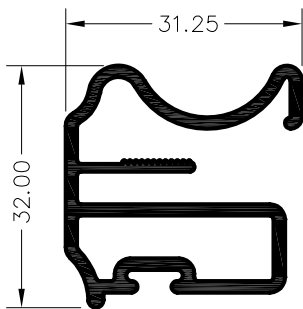

4079
PESO TEORICO 0.615 KG/M
PERIMETRO 0.312 MTS

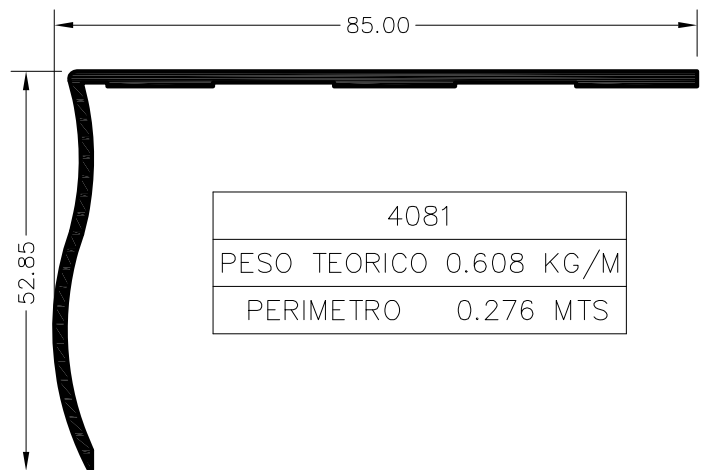

4081
PESO TEORICO 0.608 KG/M
PERIMETRO 0.276 MTS

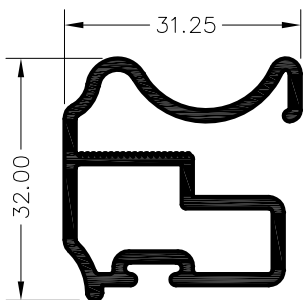

4080
PESO TEORICO 0.581 KG/M
PERIMETRO 0.298 MTS

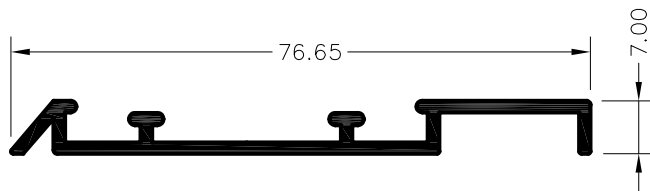

4082
PESO TEORICO 0.451 KG/M
PERIMETRO 0.221 MTS

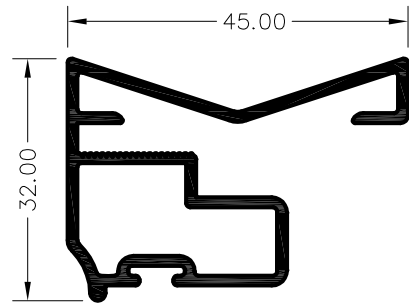

4083
PESO TEORICO 0.594 KG/M
PERIMETRO 0.347 MTS

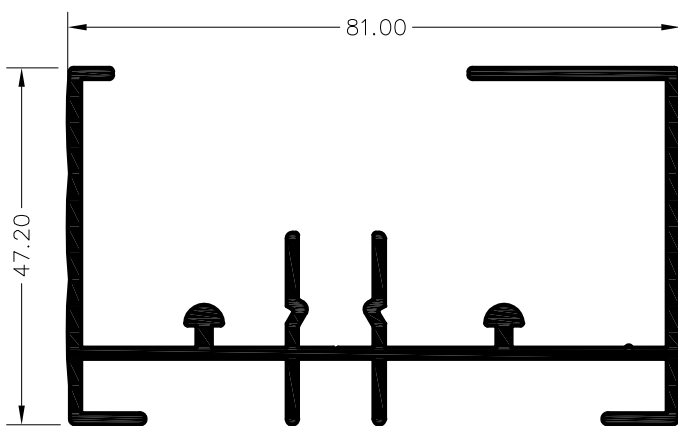

2400
PESO TEORICO 1.220 KG/M
PERIMETRO 0.565 MTS

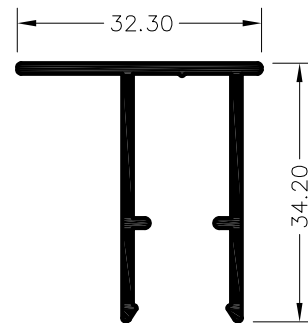

2401
PESO TEORICO 0.386 KG/M
PERIMETRO 0.205 MTS

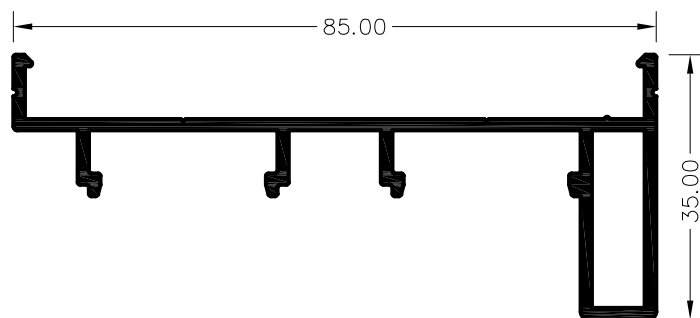

2402
PESO TEORICO 0.778 KG/M
PERIMETRO 0.381 MTS

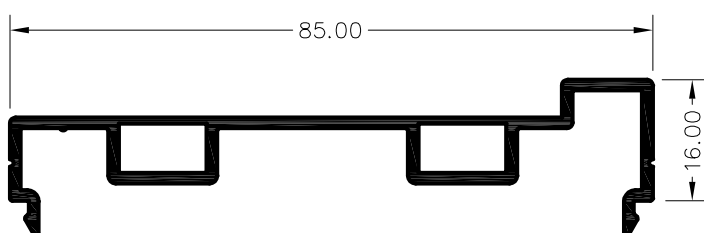

2403
PESO TEORICO 0.636 KG/M
PERIMETRO 0.356 MTS

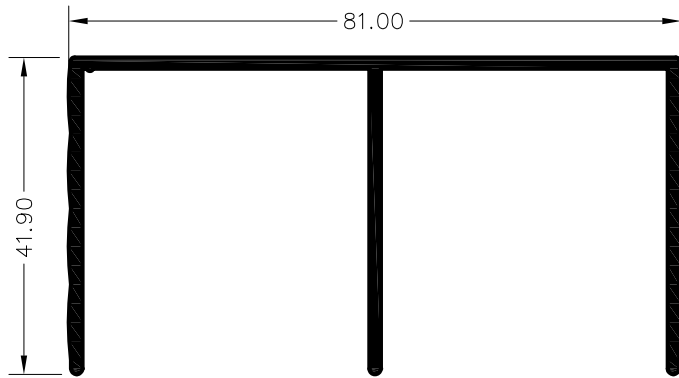

2404	
PESO TEORICO	0.859 KG/M
PERIMETRO	0.404 MTS

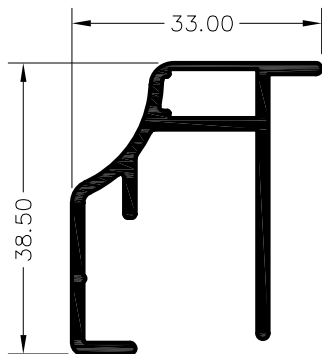

2405	
PESO TEORICO	0.489 KG/M
PERIMETRO	0.247 MTS

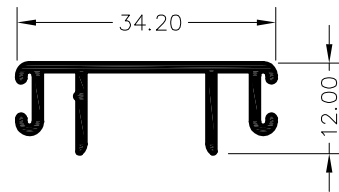

2406	
PESO TEORICO	0.235 KG/M
PERIMETRO	0.159 MTS

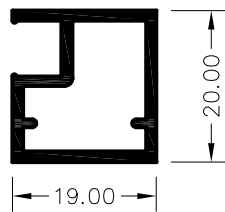

4424	
PESO TEORICO	0.297 KG/M
PERIMETRO	0.165 MTS

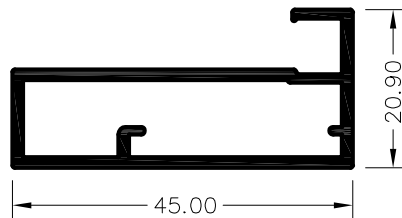

4425	
PESO TEORICO	0.491 KG/M
PERIMETRO	0.265 MTS

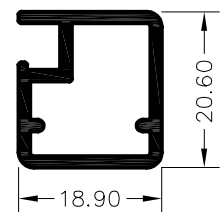

4432	
PESO TEORICO	0.327 KG/M
PERIMETRO	0.161 MTS

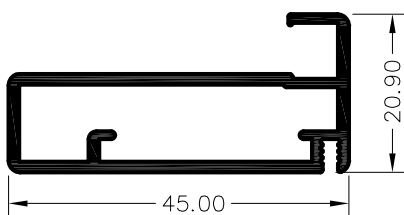

4440	
PESO TEORICO	0.440 KG/M
PERIMETRO	0.273 MTS

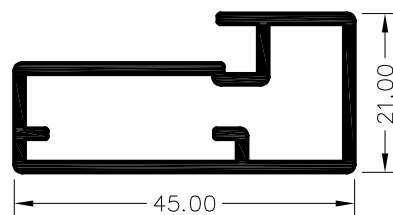

4750	
PESO TEORICO	0.543 KG/M
PERIMETRO	0.286 MTS



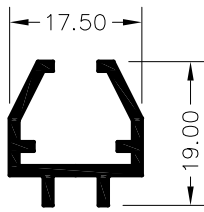

400
PESO TEORICO 0.197 KG/M
PERIMETRO 0.124 MTS

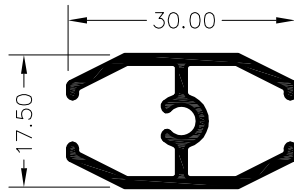

401
PESO TEORICO 0.289 KG/M
PERIMETRO 0.178 MTS

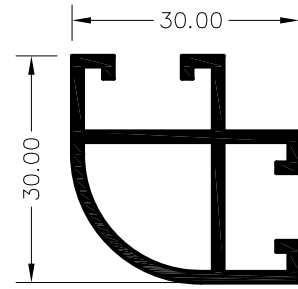

500
PESO TEORICO 0.491 KG/M
PERIMETRO 0.260 MTS

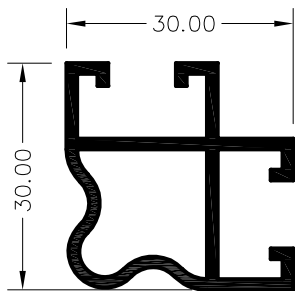

501
PESO TEORICO 0.521 KG/M
PERIMETRO 0.276 MTS

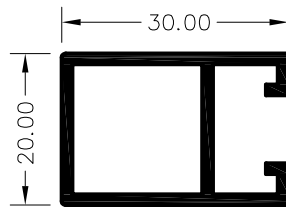

507
PESO TEORICO 0.400 KG/M
PERIMETRO 0.212 MTS

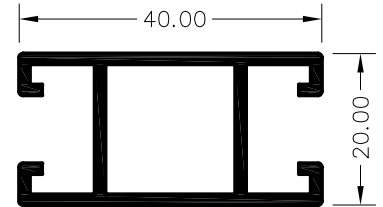

508
PESO TEORICO 0.516 KG/M
PERIMETRO 0.273 MTS

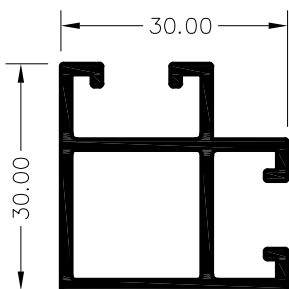

509
PESO TEORICO 0.518 KG/M
PERIMETRO 0.270 MTS

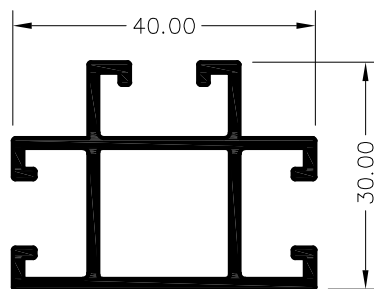

512
PESO TEORICO 0.616 KG/M
PERIMETRO 0.332 MTS

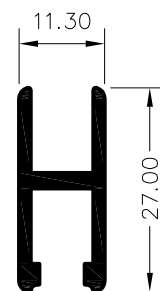

518
PESO TEORICO 0.275 KG/M
PERIMETRO 0.127 MTS

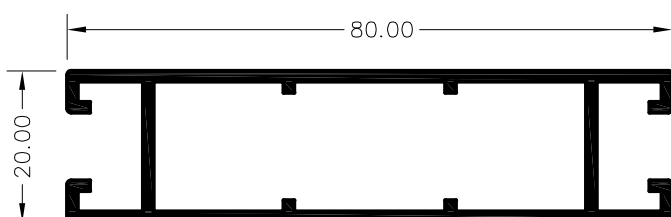

513
PESO TEORICO 0.842 KG/M
PERIMETRO 0.445 MTS

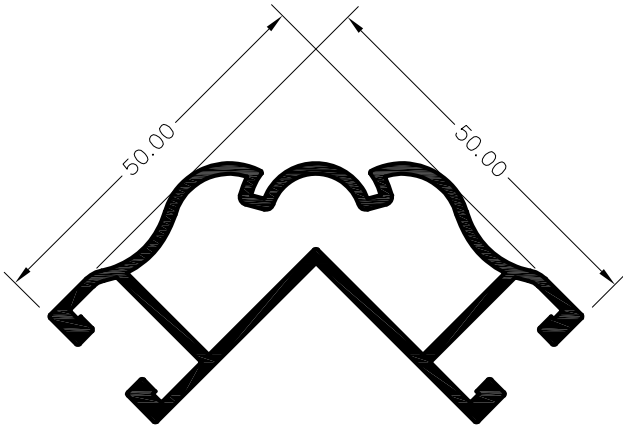

524
PESO TEORICO 0.856 KG/M
PERIMETRO 0.422 MTS

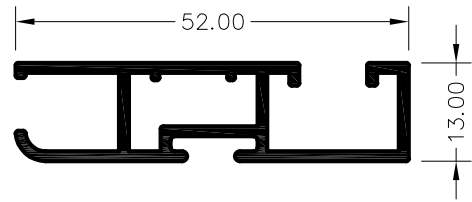

530
PESO TEORICO 0.494 KG/M
PERIMETRO 0.281 MTS

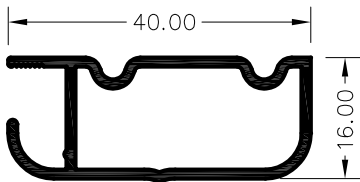

550
PESO TEORICO 0.370 KG/M
PERIMETRO 0.231 MTS

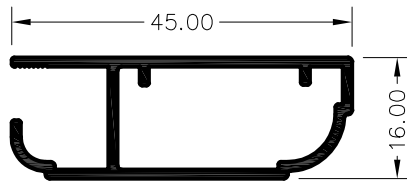

3100
PESO TEORICO 0.399 KG/M
PERIMETRO 0.247 MTS

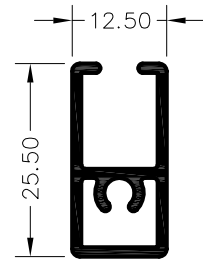

556
PESO TEORICO 0.278 KG/M
PERIMETRO 0.165 MTS

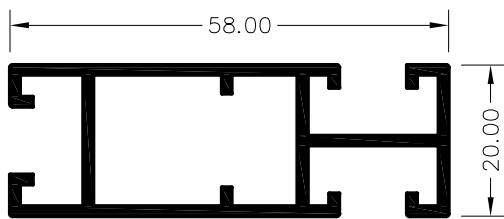

536
PESO TEORICO 0.675 KG/M
PERIMETRO 0.381 MTS