

8010	
PESO TEORICO	0.664 KG/M
PERIMETRO	0.408 MTS

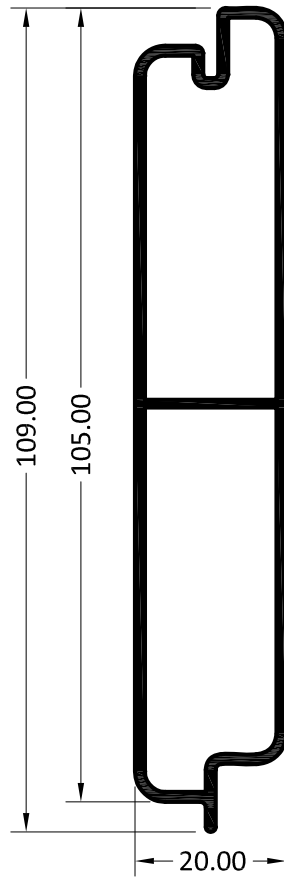

8015	
PESO TEORICO	0.923 KG/M
PERIMETRO	0.531 MTS

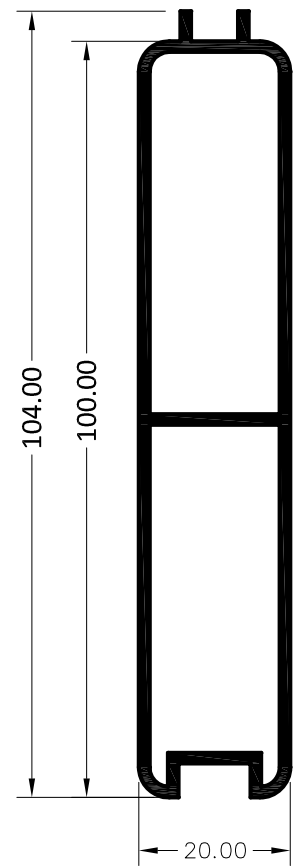

8048	
PESO TEORICO	0.994 KG/M
PERIMETRO	0.523 MTS

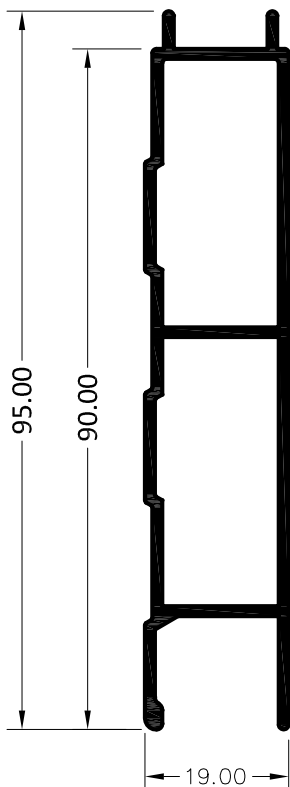

8051	
PESO TEORICO	0.848 KG/M
PERIMETRO	0.473 MTS

4217	
PESO TEORICO	0.932 KG/M
PERIMETRO	0.526 MTS

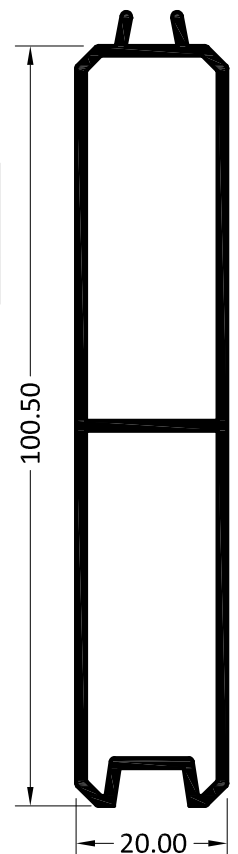

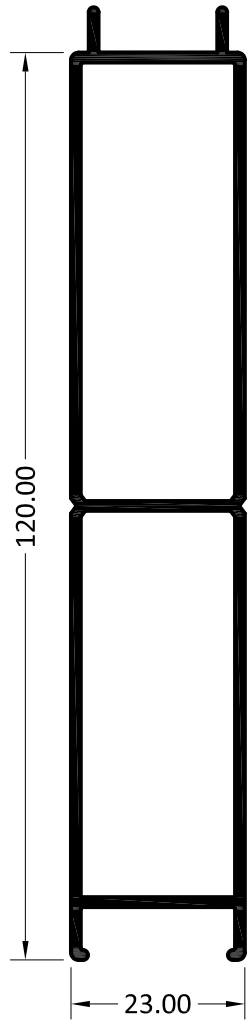

6346
PESO TEORICO 1.102 KG/M
PERIMETRO 0.622 MTS

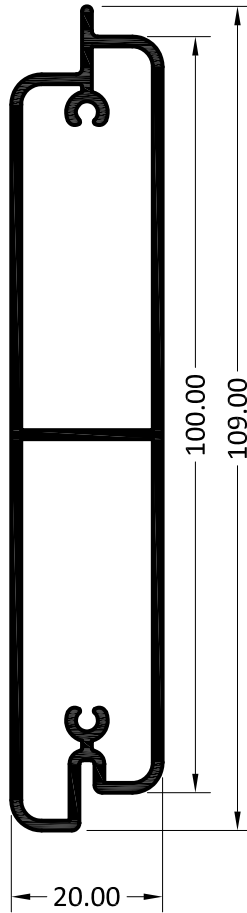

11275
PESO TEORICO 1.015 KG/M
PERIMETRO 0.575 MTS

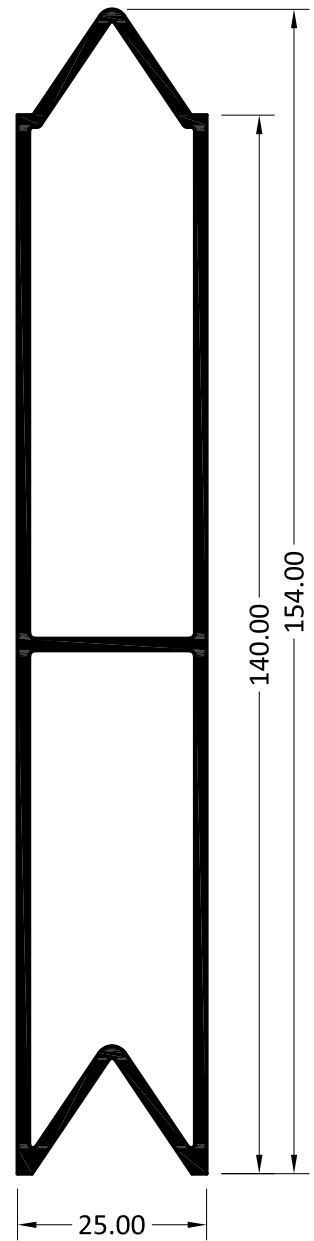

9102
PESO TEORICO 1.580 KG/M
PERIMETRO 0.742 MTS

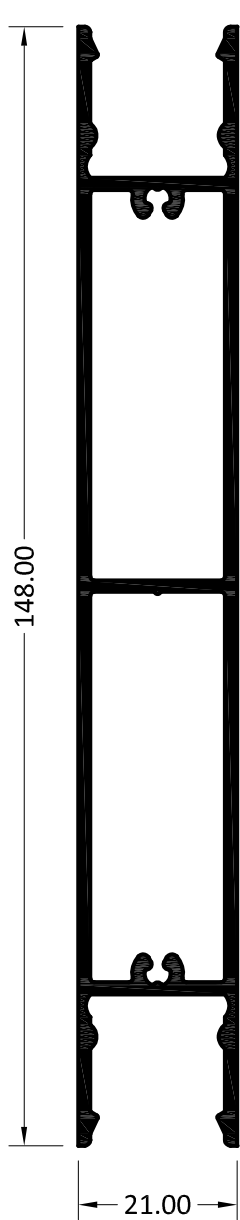

6425
PESO TEORICO 1.598 KG/M
PERIMETRO 0.728 MTS

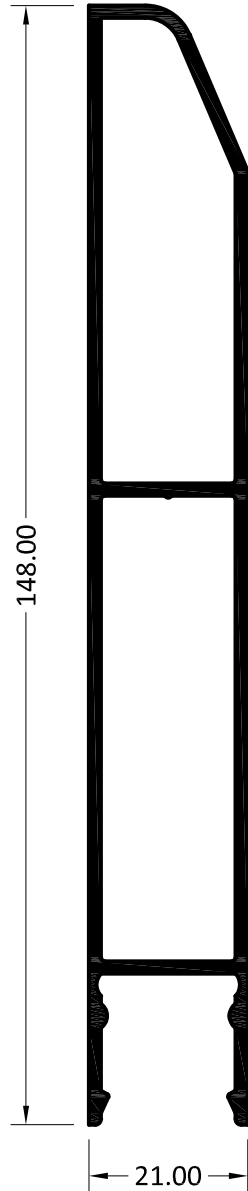

6433
PESO TEORICO 1.488 KG/M
PERIMETRO 0.681 MTS

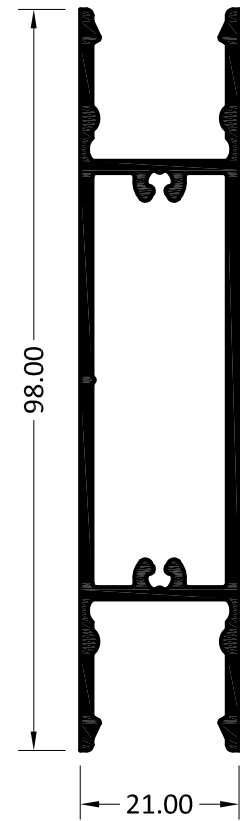

6426
PESO TEORICO 1.094 KG/M
PERIMETRO 0.497 MTS

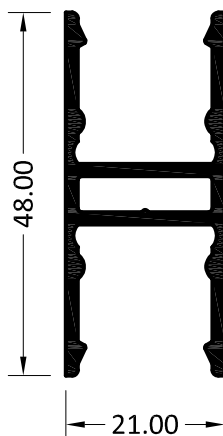

6427
PESO TEORICO 0.591 KG/M
PERIMETRO 0.268 MTS

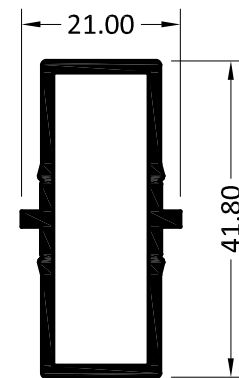

6432
PESO TEORICO 0.481 KG/M
PERIMETRO 0.228 MTS

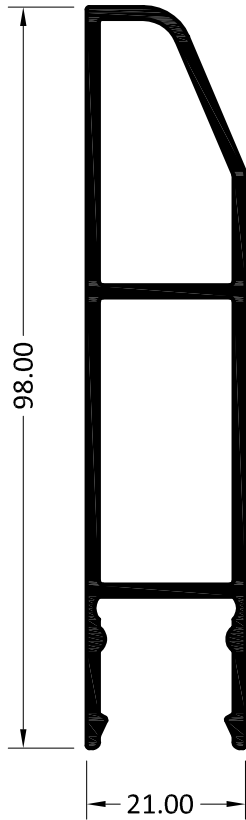

6447
PESO TEORICO 1.055 KG/M
PERIMETRO 0.480 MTS

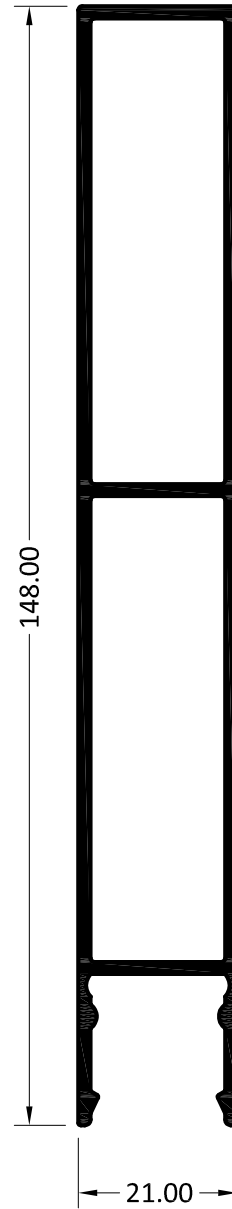

6448
PESO TEORICO 1.520 KG/M
PERIMETRO 0.696 MTS

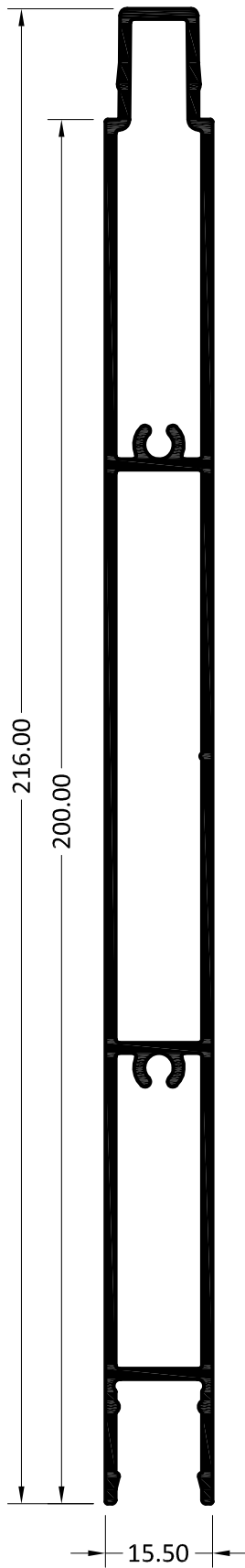

6435
PESO TEORICO 2.044 KG/M
PERIMETRO 0.988 MTS

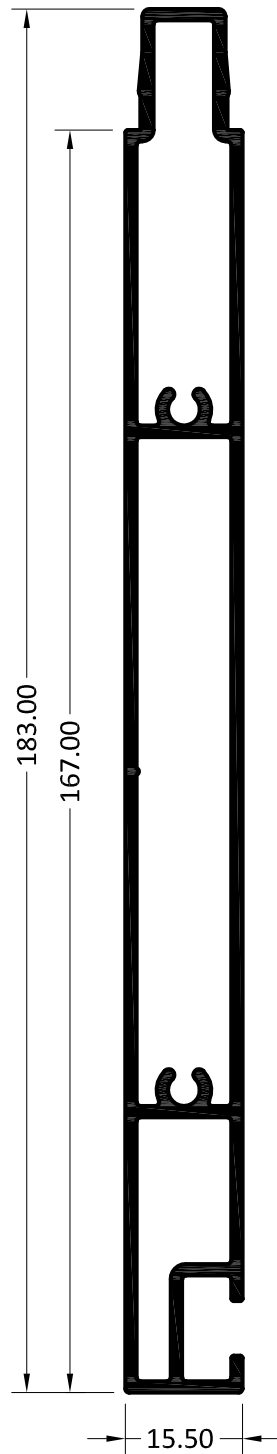

6436
PESO TEORICO 1.841 KG/M
PERIMETRO 0.882 MTS

6437
PESO TEORICO 1.837 KG/M
PERIMETRO 0.886 MTS

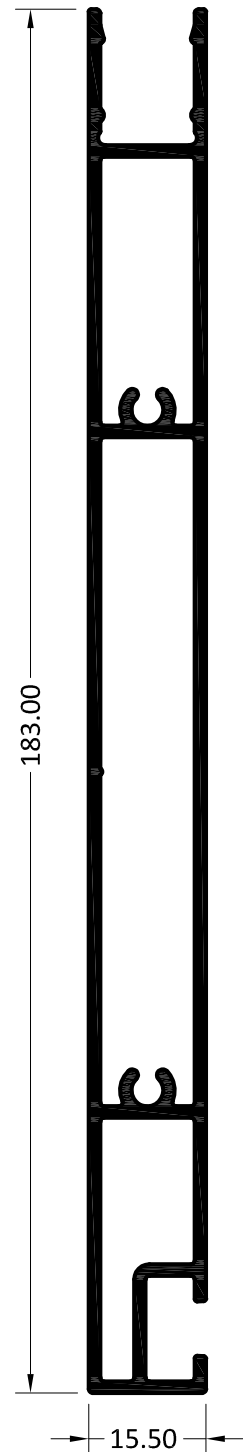

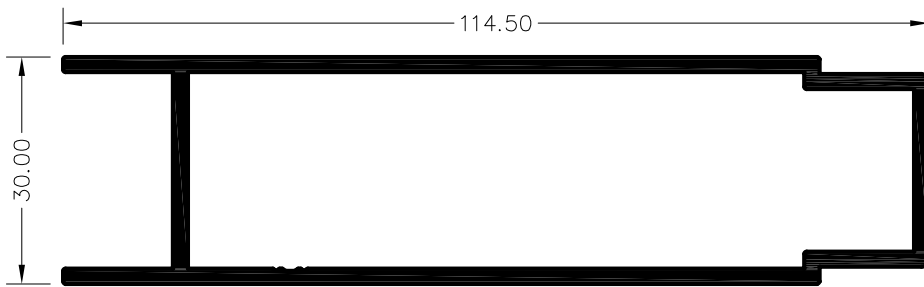

42002	
PESO TEORICO	1.514 KG/M
PERIMETRO	0.561 MTS

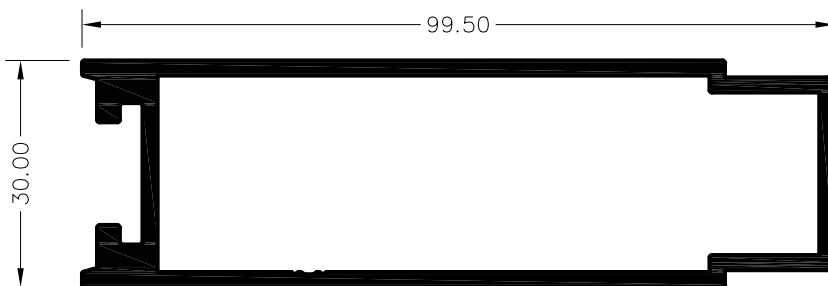

42004	
PESO TEORICO	1.514 KG/M
PERIMETRO	0.509 MTS

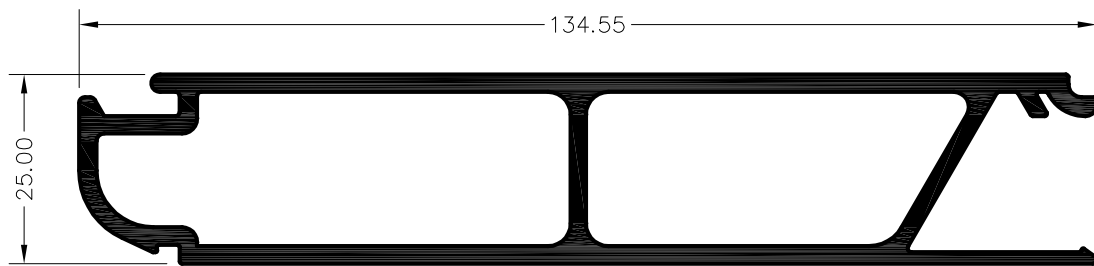

30241	
PESO TEORICO	2.064 KG/M
PERIMETRO	0.664 MTS

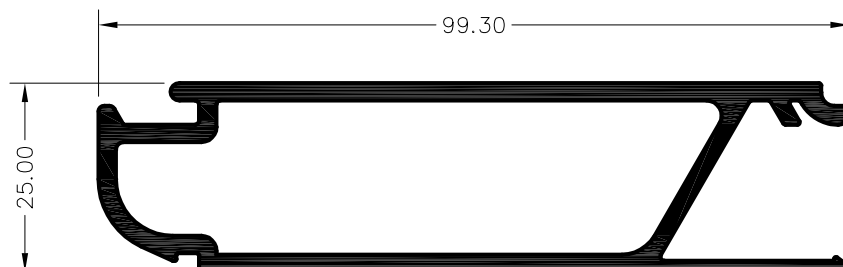

30242	
PESO TEORICO	1.495 KG/M
PERIMETRO	0.492 MTS

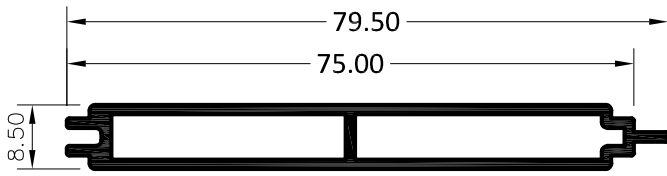

5630
PESO TEORICO 0.597 KG/M
PERIMETRO 0.339 MTS

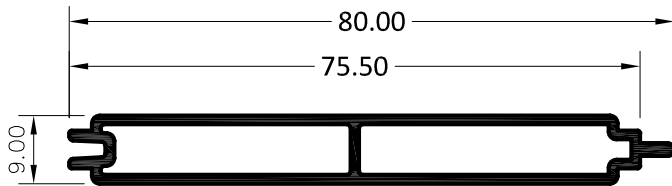

8126
PESO TEORICO 0.560 KG/M
PERIMETRO 0.348 MTS

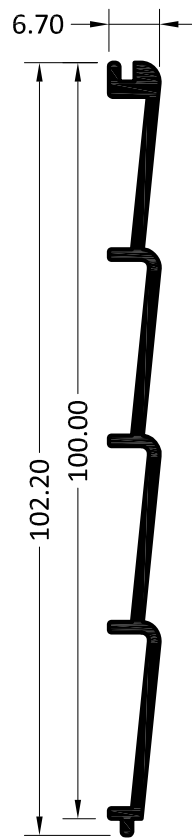

10131
PESO TEORICO 0.497 KG/M
PERIMETRO 0.285 MTS

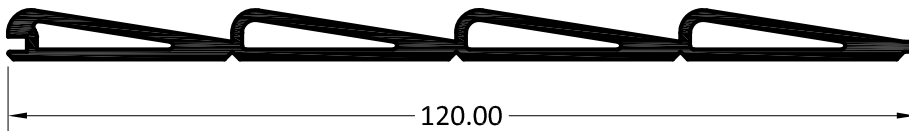

543
PESO TEORICO 0.909 KG/M
PERIMETRO 0.438 MTS

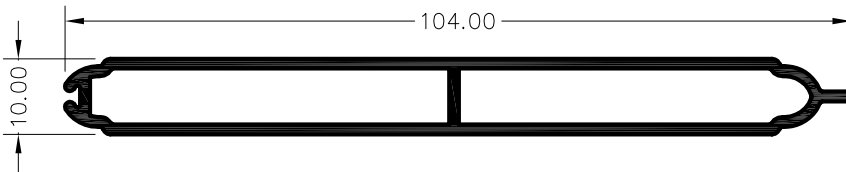

2515
PESO TEORICO 0.775 KG/M
PERIMETRO 0.436 MTS

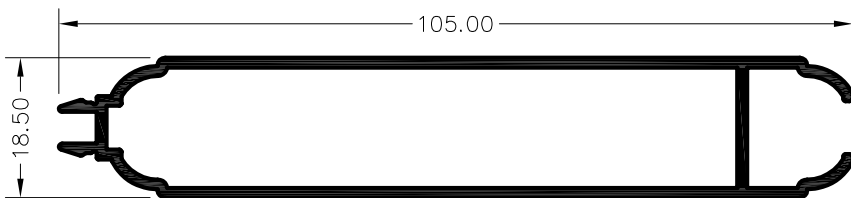

2560
PESO TEORICO 0.840 KG/M
PERIMETRO 0.479 MTS

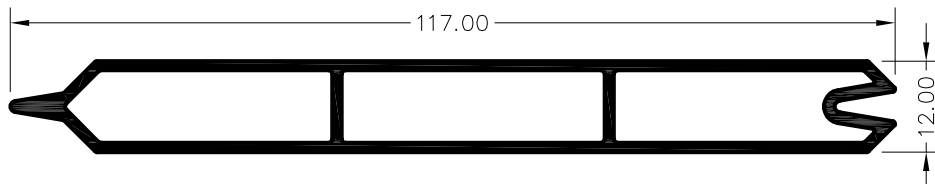

16279
PESO TEORICO 0.899 KG/M
PERIMETRO 0.527 MTS

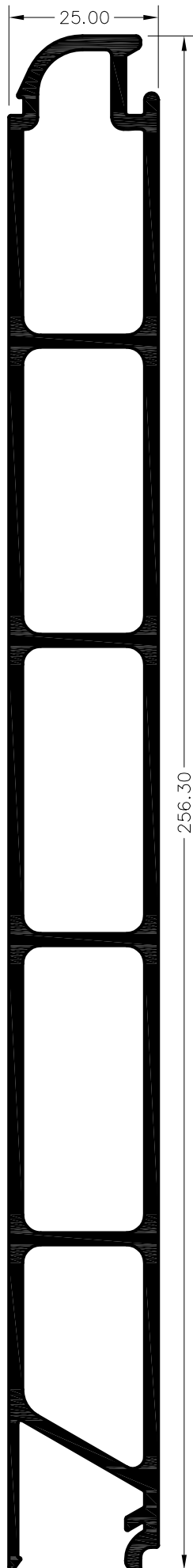

30243	
PESO TEORICO	3.969 KG/M
PERIMETRO	1.246 MTS

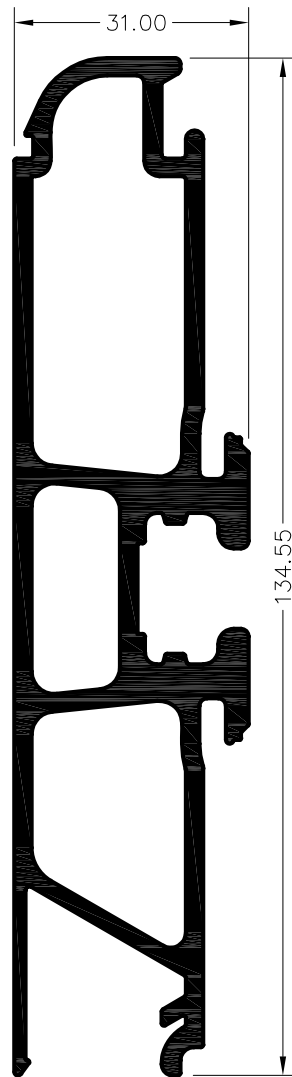

30244	
PESO TEORICO	2.730 KG/M
PERIMETRO	0.757 MTS

30245	
PESO TEORICO	5.170 KG/M
PERIMETRO	1.400 MTS

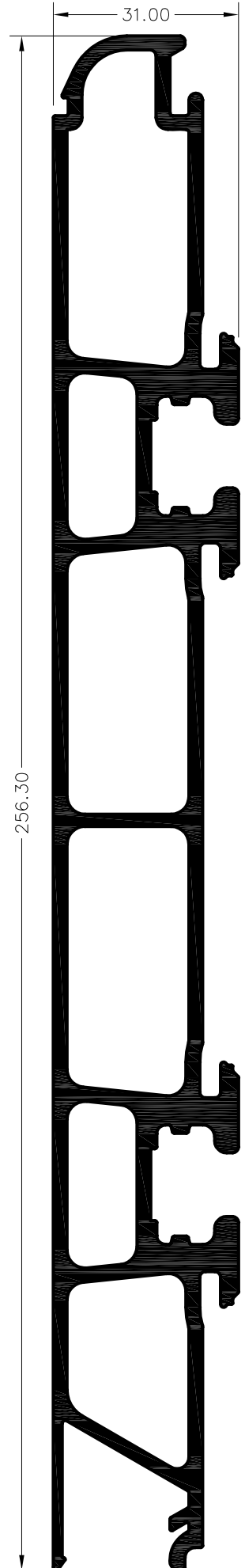

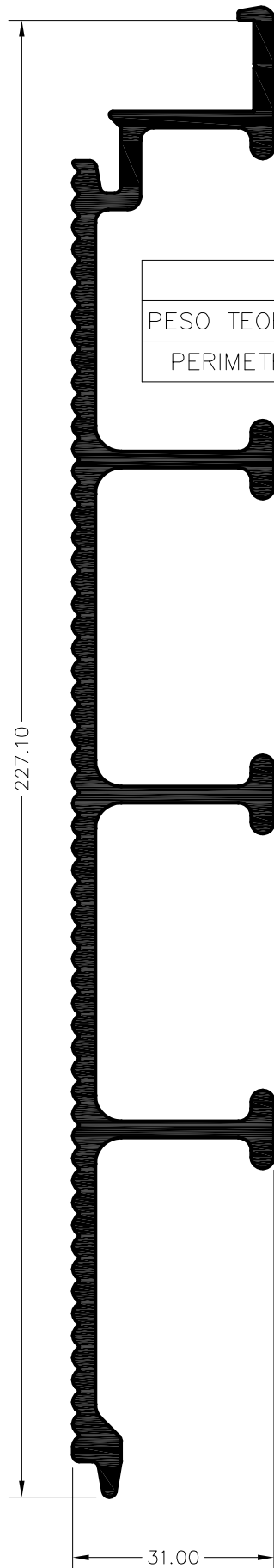

30229	
PESO TEORICO	3.155 KG/M
PERIMETRO	0.778 MTS

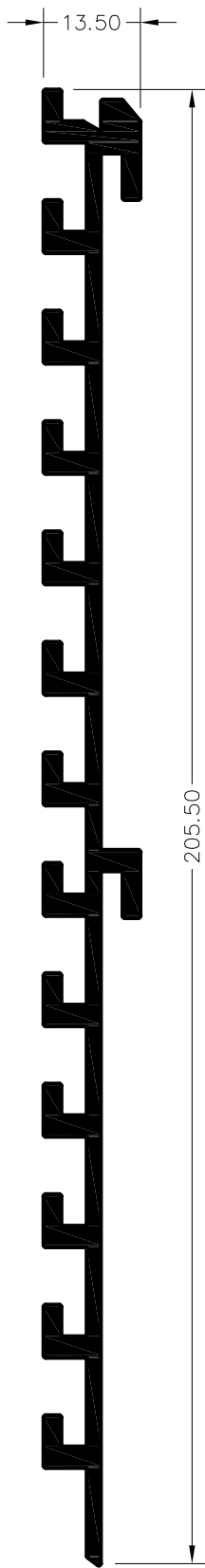

17084
PESO TEORICO 2.329 KG/M
PERIMETRO 0.725 MTS

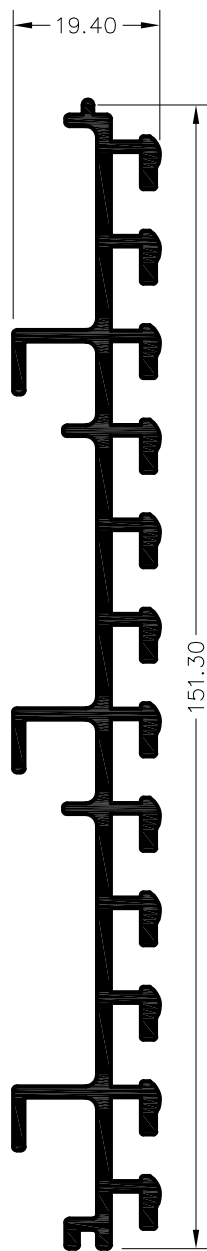

10476
PESO TEORICO 1.706 KG/M
PERIMETRO 0.714 MTS

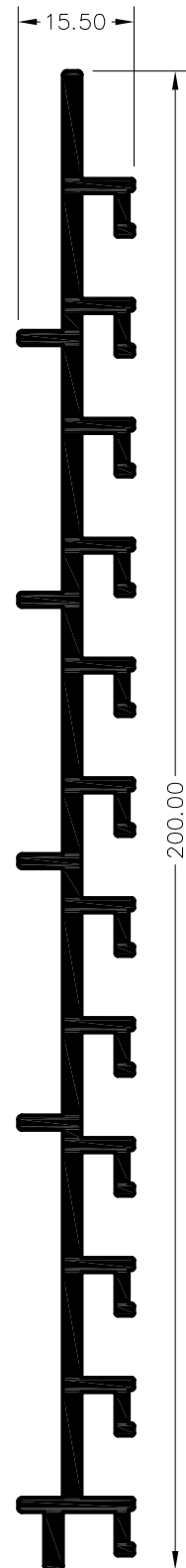

30000
PESO TEORICO 2.297 KG/M
PERIMETRO 0.778 MTS

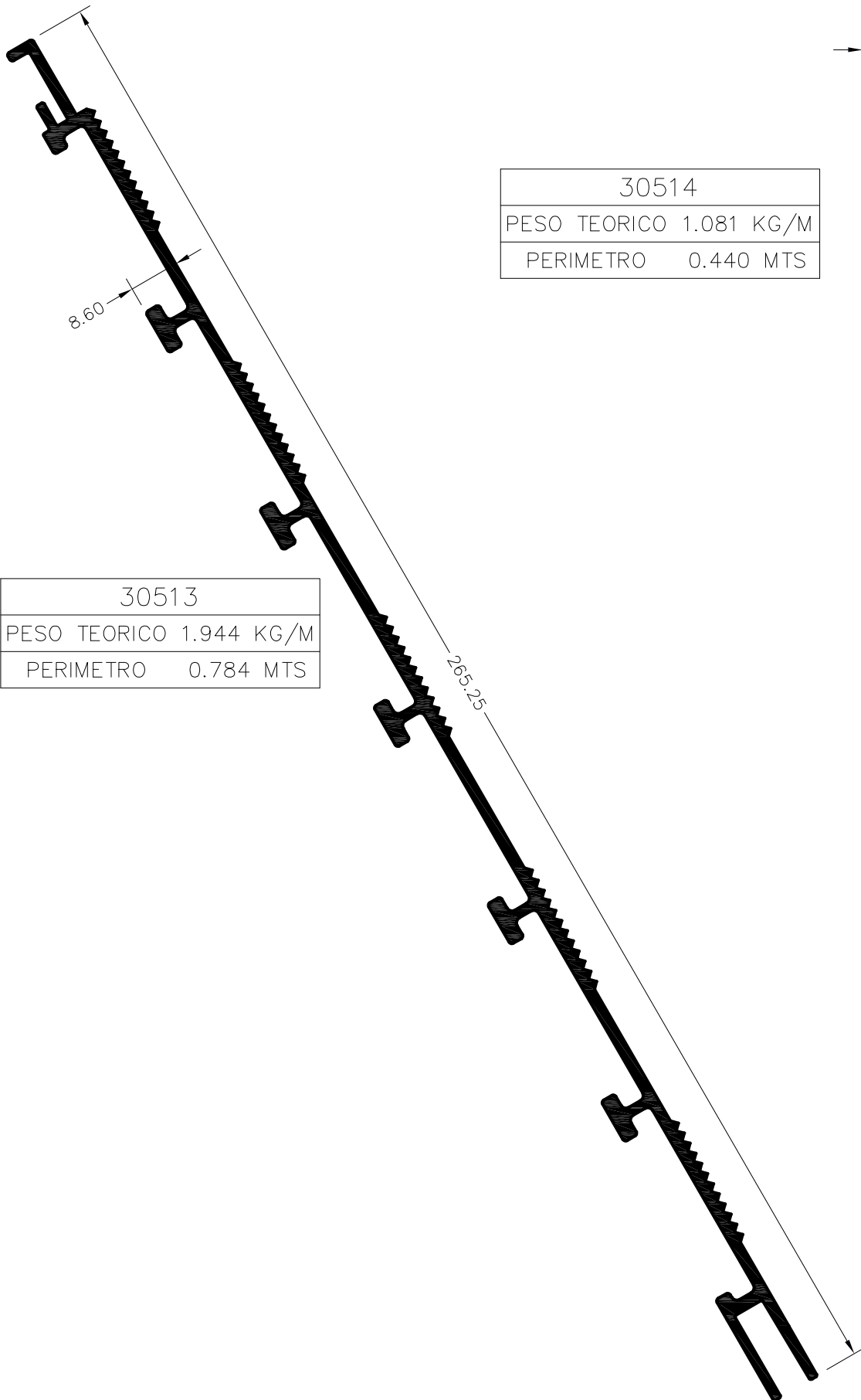

30513
PESO TEORICO 1.944 KG/M
PERIMETRO 0.784 MTS

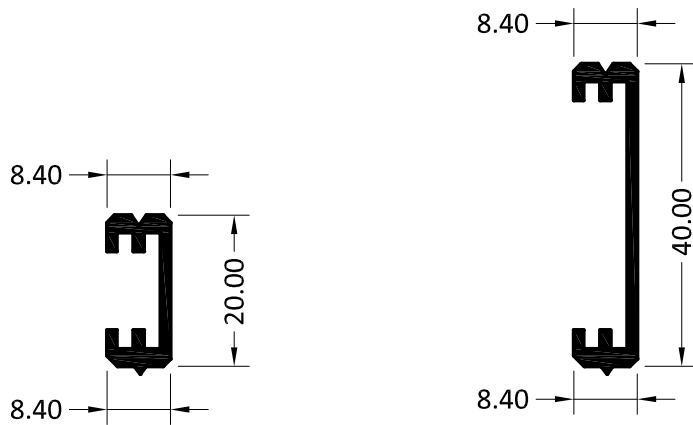

10015
PESO TEORICO 0.707 KG/M
PERIMETRO 0.349 MTS

10020
PESO TEORICO 0.186 KG/M
PERIMETRO 0.091 MTS

10019
PESO TEORICO 0.256 KG/M
PERIMETRO 0.131 MTS

10017
PESO TEORICO 0.397 KG/M
PERIMETRO 0.211 MTS

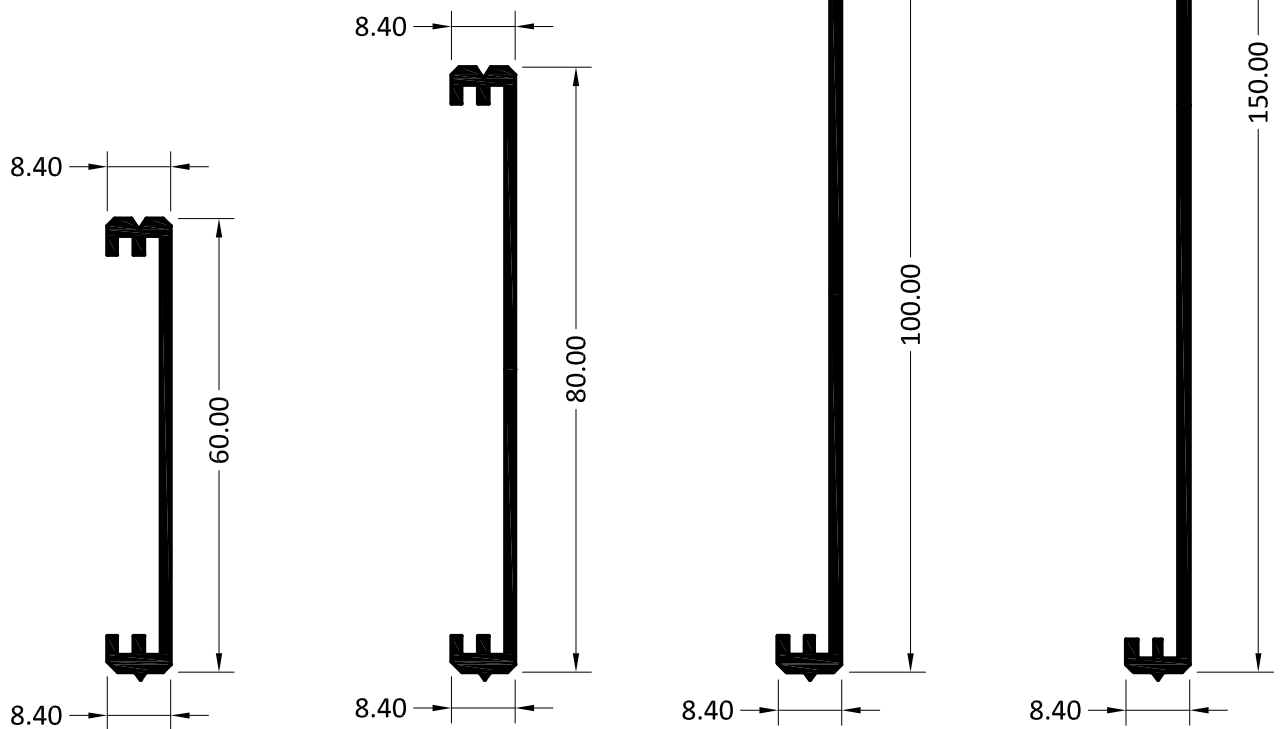

10018
PESO TEORICO 0.327 KG/M
PERIMETRO 0.171 MTS

10016
PESO TEORICO 0.491 KG/M
PERIMETRO 0.253 MTS

10668	
PESO TEORICO	3.766 KG/M
PERIMETRO	0.733 MTS

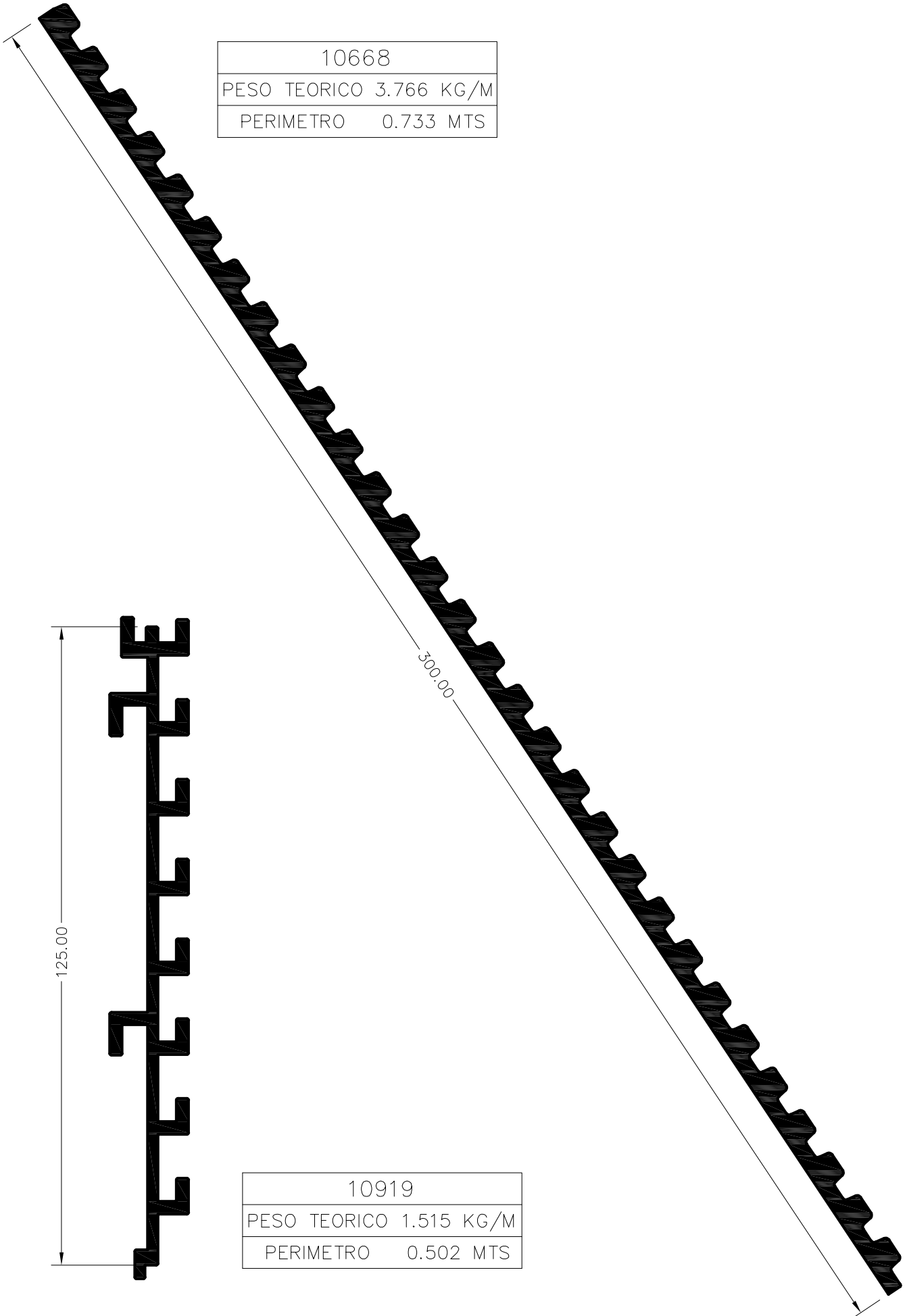

10919	
PESO TEORICO	1.515 KG/M
PERIMETRO	0.502 MTS

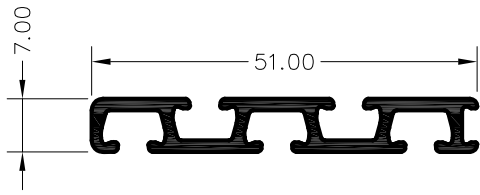

13732	
PESO TEORICO	0.397 KG/M
PERIMETRO	0.207 MTS

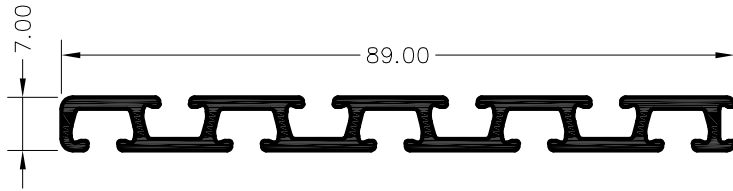

13733	
PESO TEORICO	0.686 KG/M
PERIMETRO	0.354 MTS

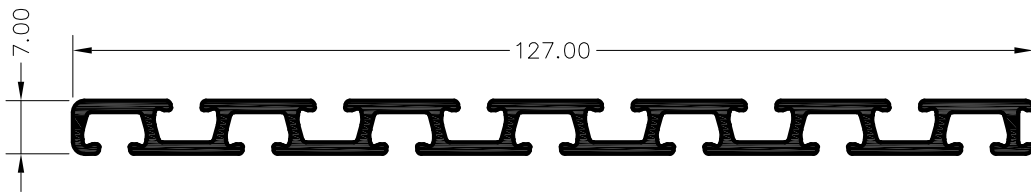

13734	
PESO TEORICO	0.974 KG/M
PERIMETRO	0.502 MTS

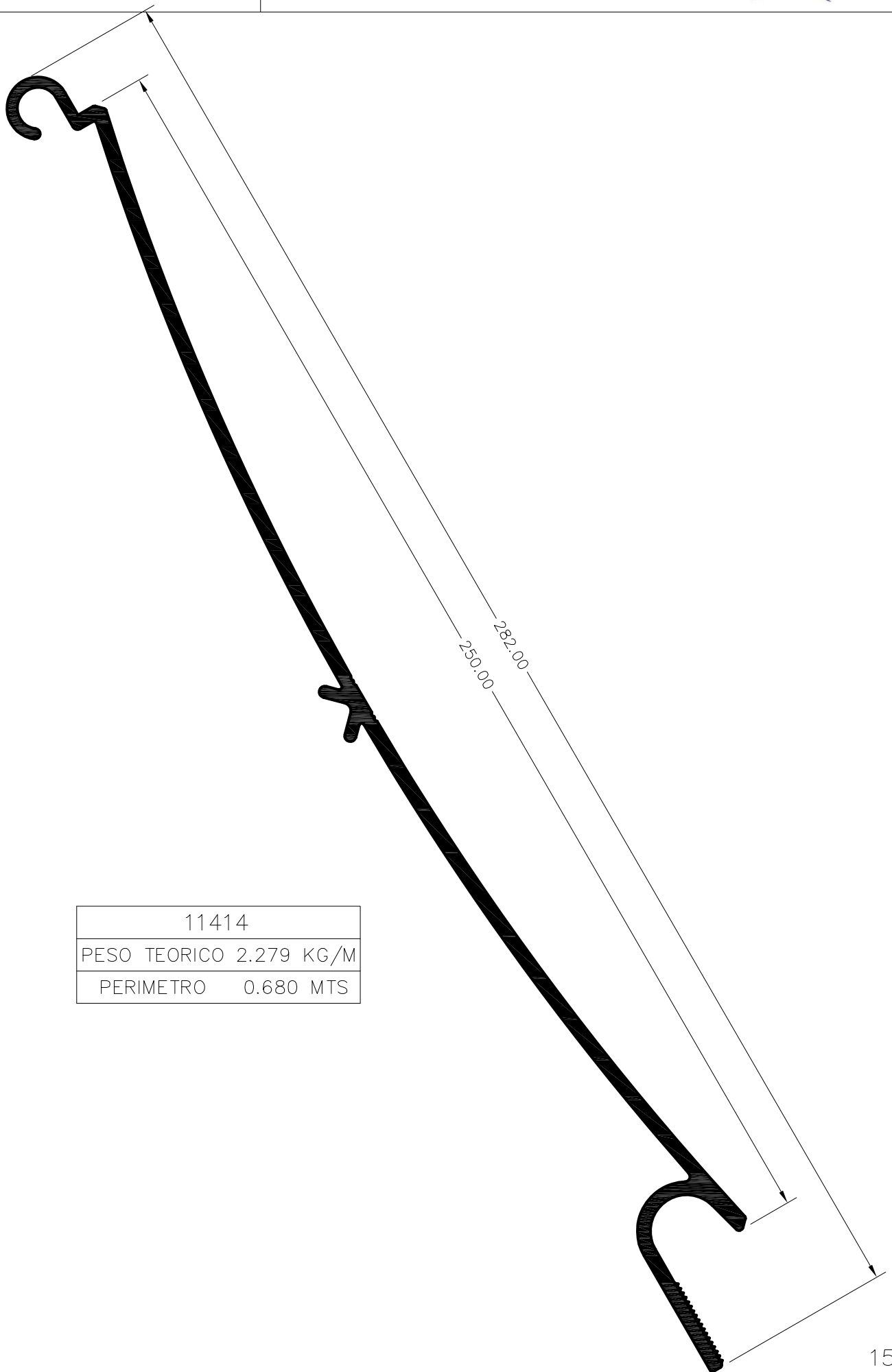

11414
PESO TEORICO 2.279 KG/M
PERIMETRO 0.680 MTS

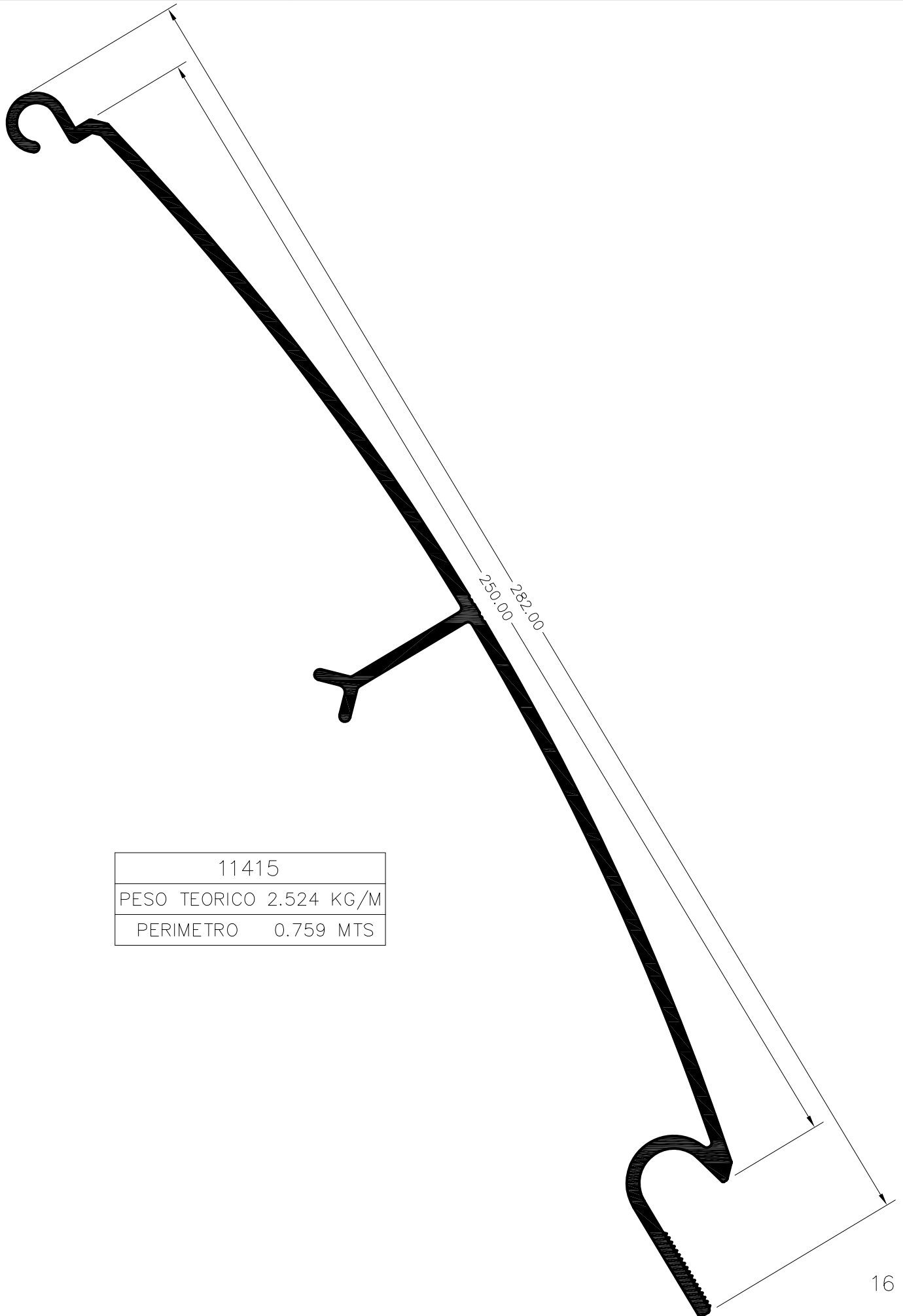

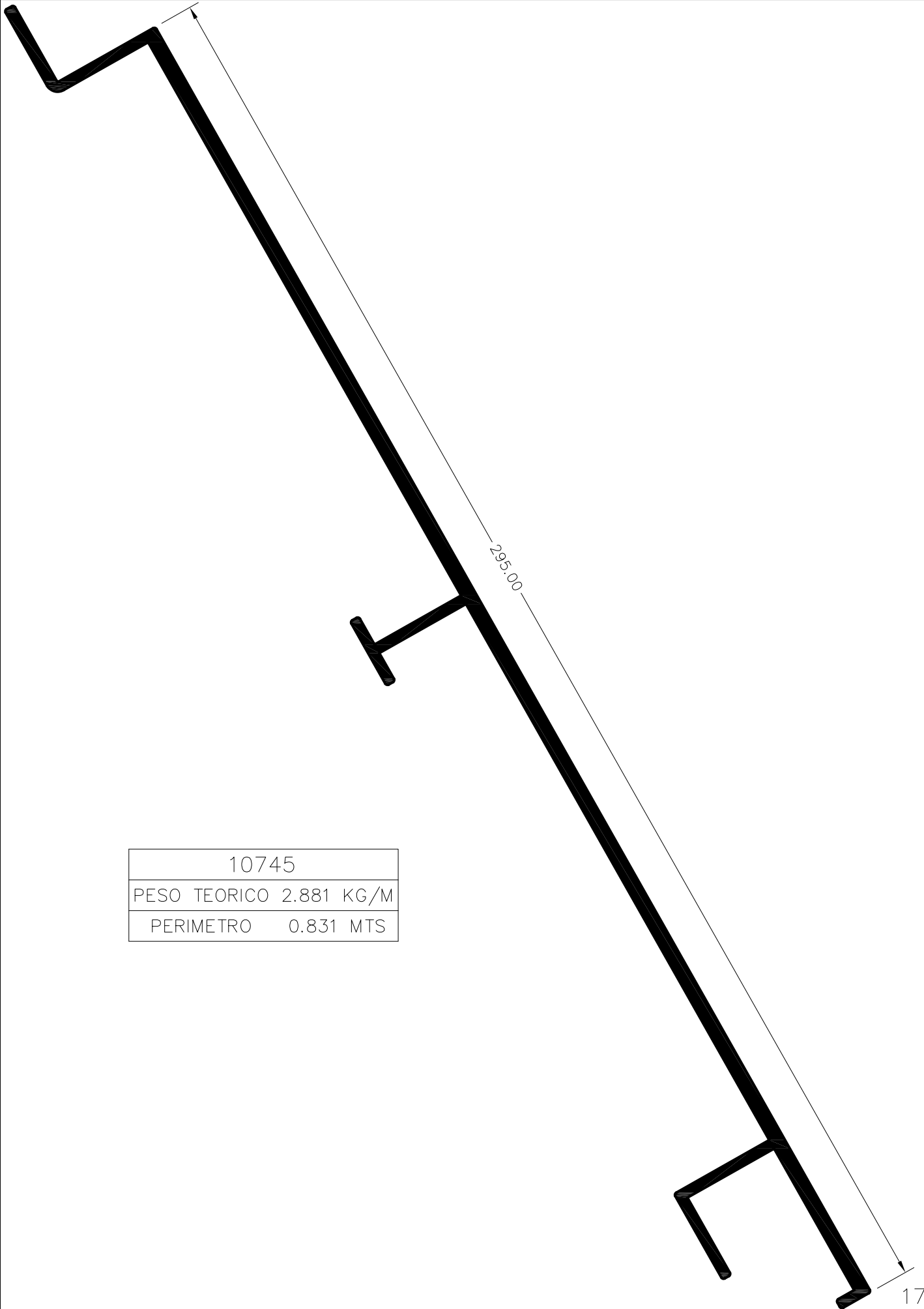

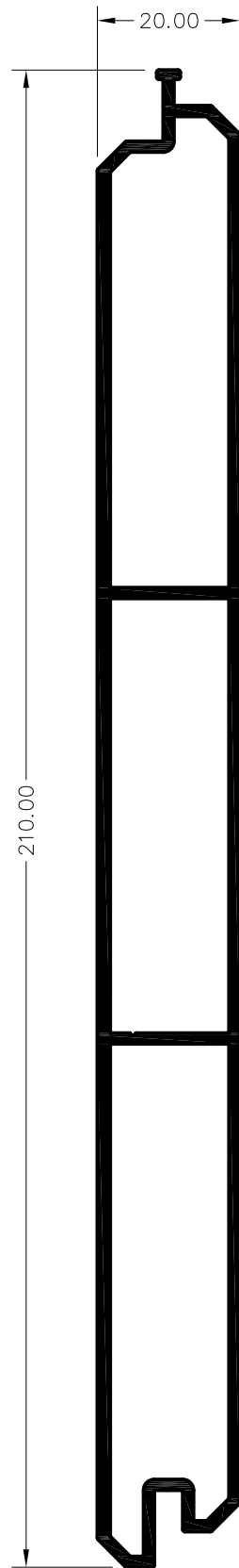

17582	
PESO TEORICO	2.123 KG/M
PERIMETRO	0.966 MTS