

16200
PESO TEORICO 0.683 KG/M
PERIMETRO 0.408 MTS

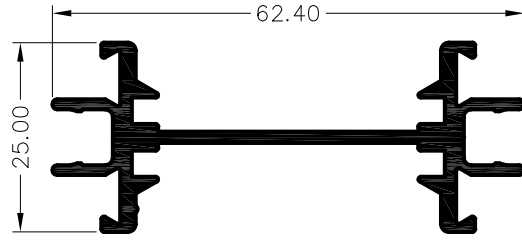

16201
PESO TEORICO 0.686 KG/M
PERIMETRO 0.298 MTS

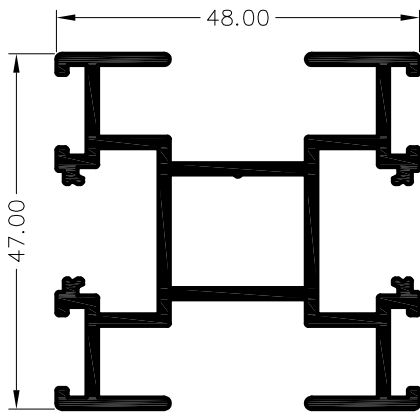

16202
PESO TEORICO 1.091 KG/M
PERIMETRO 0.530 MTS

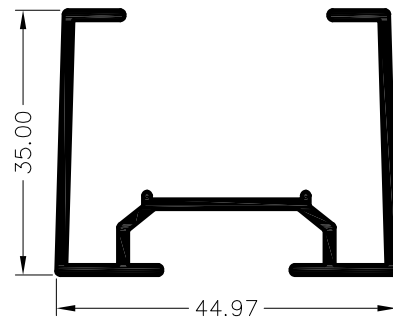

16203
PESO TEORICO 0.526 KG/M
PERIMETRO 0.300 MTS

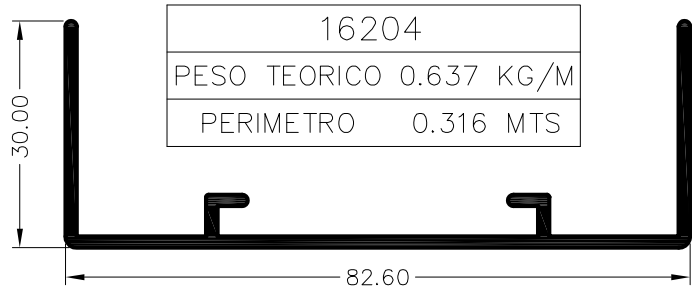

16204
PESO TEORICO 0.637 KG/M
PERIMETRO 0.316 MTS

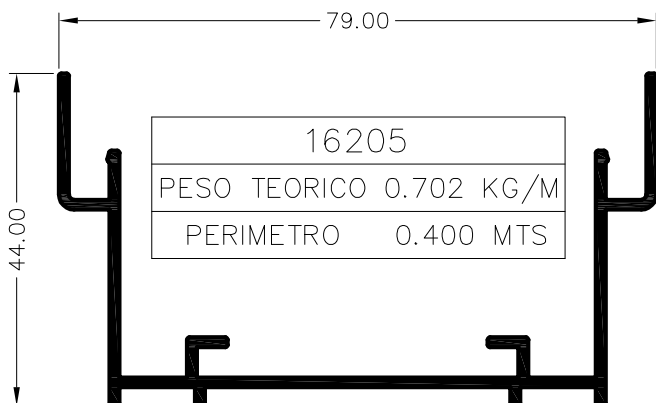

16205
PESO TEORICO 0.702 KG/M
PERIMETRO 0.400 MTS

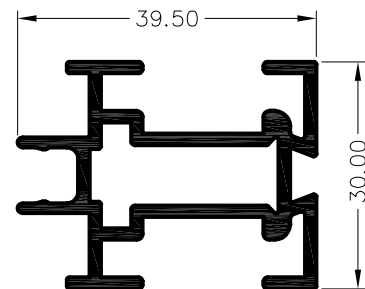

16206
PESO TEORICO 0.726 KG/M
PERIMETRO 0.344 MTS

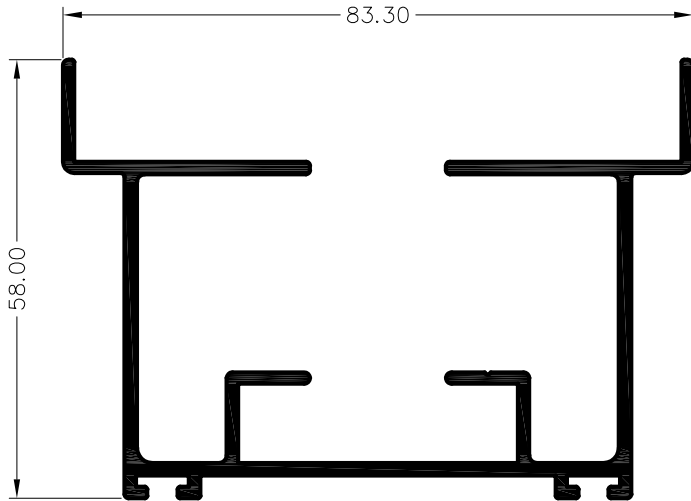

16207
PESO TEORICO 1.279 KG/M
PERIMETRO 0.586 MTS

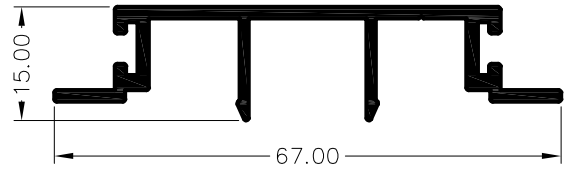

16209
PESO TEORICO 0.508 KG/M
PERIMETRO 0.256 MTS

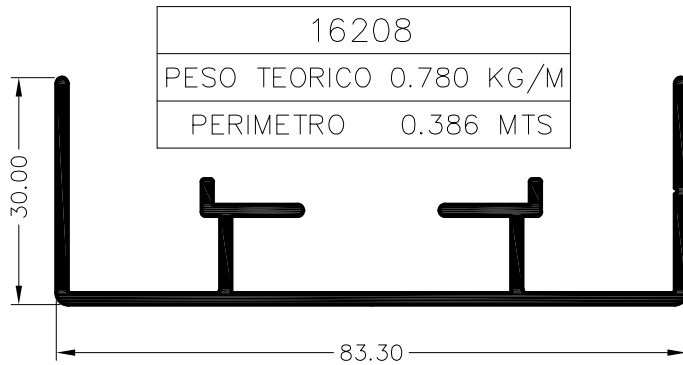

16208
PESO TEORICO 0.780 KG/M
PERIMETRO 0.386 MTS

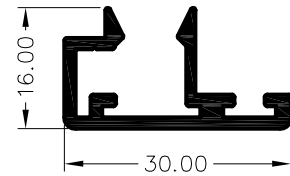

16210
PESO TEORICO 0.321 KG/M
PERIMETRO 0.154 MTS

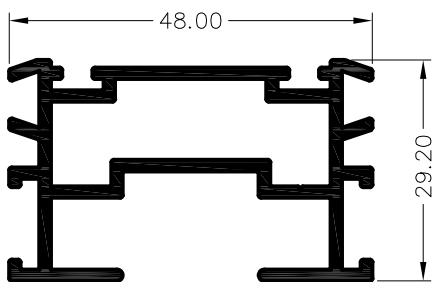

16211
PESO TEORICO 0.839 KG/M
PERIMETRO 0.411 MTS

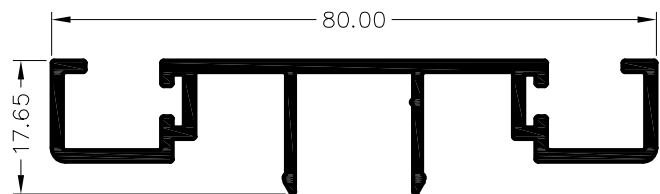

16212
PESO TEORICO 0.694 KG/M
PERIMETRO 0.353 MTS

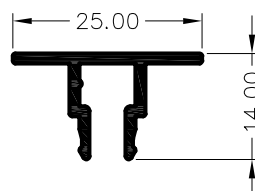

16213
PESO TEORICO 0.180 KG/M
PERIMETRO 0.107 MTS

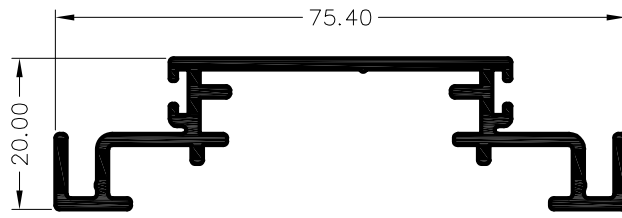

16214	
PESO TEORICO	0.682 KG/M
PERIMETRO	0.334 MTS

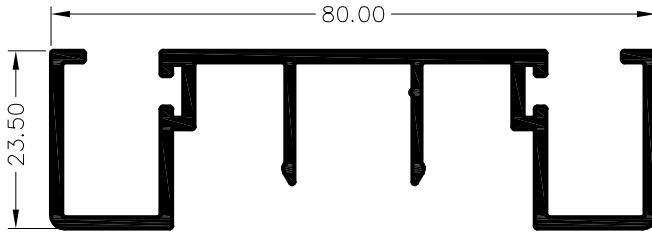

16215	
PESO TEORICO	0.859 KG/M
PERIMETRO	0.434 MTS

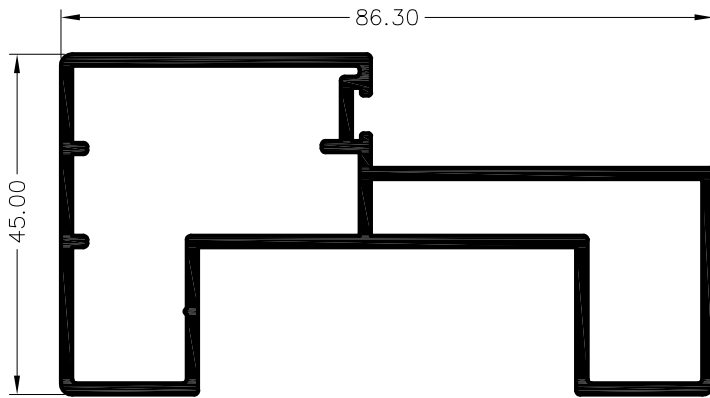

16216	
PESO TEORICO	1.277 KG/M
PERIMETRO	0.624 MTS

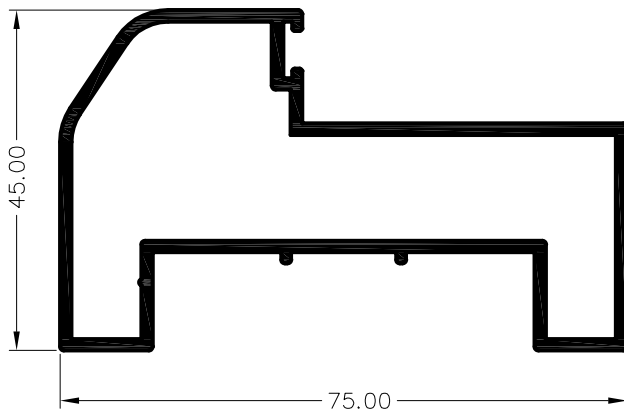

16217	
PESO TEORICO	1.050 KG/M
PERIMETRO	0.518 MTS

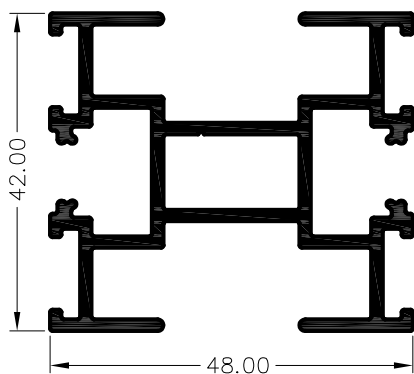

16216	
PESO TEORICO	1.053 KG/M
PERIMETRO	0.504 MTS

