













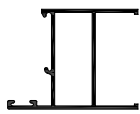
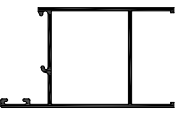

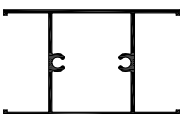
SERIE MALLORQUINA

1. RELACIÓN DE PERFILES
2. PERFILES
3. SECCIONES
4. LISTA DE CORTE





1. RELACION DE PERFILES

Sección	Referencia	Denominación	Peso (kg)	Perímetro (m)
	3650	Hoja ventana mallorquina S-1000	0,629	0,355
	3651	Hoja puerta mallorquina S-1000	0,748	0,421
	3652	Montante	0,189	0,110
	3653	Travesaño 66.50 mm	0,815	0,456
	3654	Travesaño de 120 mm	1,485	0,777
	3655	Media lama mínima	0,286	0,208
	3656	Media lama máxima	0,375	0,274
	3657	Perfil base ancho 28 mm	0,267	0,162
	3658	Perfil base 40 mm	0,308	0,186
	3660	Lama para celosía	0,302	0,156
	4411	Lama fija	0,294	0,216
	4412	Lama móvil 71 mm	0,526	0,341
	4416	Hoja mallorquina ventana S-1200	0,732	0,371
	8009	Lama móvil 60 mm	0,405	0,260

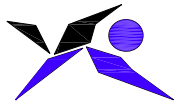

2. PERFILES

3650
HOJA VENTANA MALLORQUINA S-1000

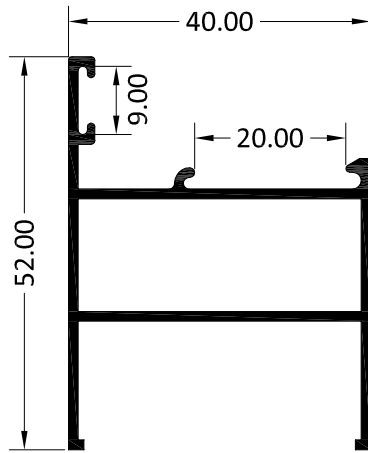

4416
HOJA VENTANA MALLORQUINA S-1200

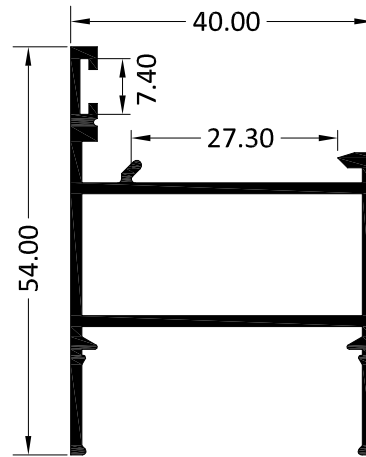

3651
HOJA PUERTA MALLORQUINA S-1000

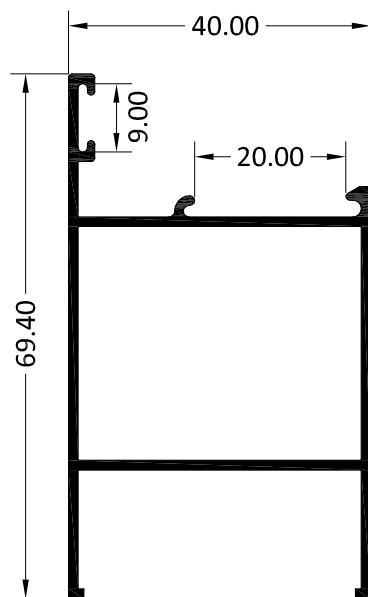

3653
TRAVESAÑO 66.50 MM

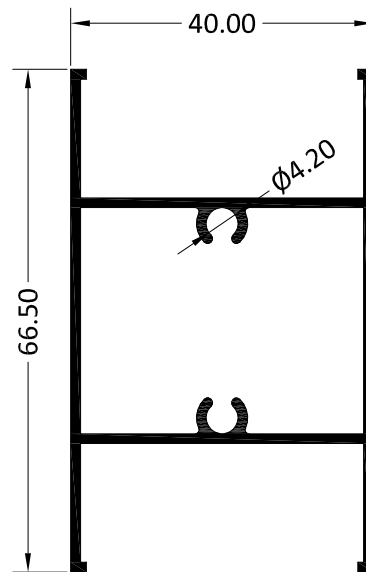

3654
TRAVESAÑO 120 MM

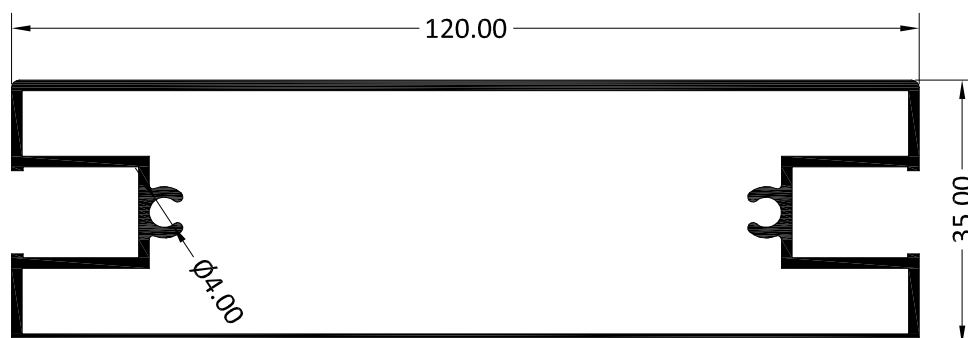



2. PERFILES

3652
MONTANTE

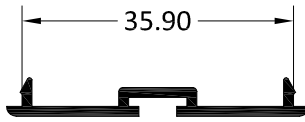

3655
MEDIA LAMA MÍNIMA

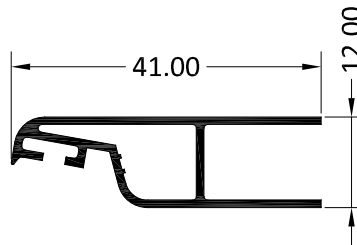

3656
MEDIA LAMA MÁXIMA

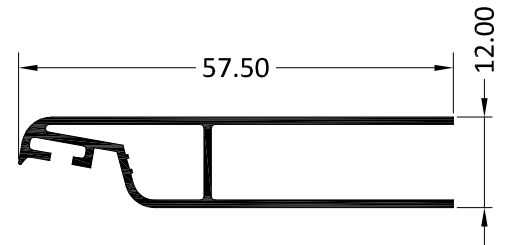

3657
PERFIL BASE 28 MM

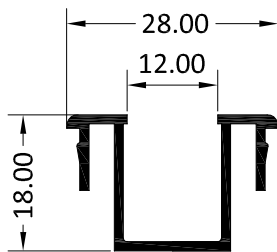

3658
PERFIL BASE 40 MM

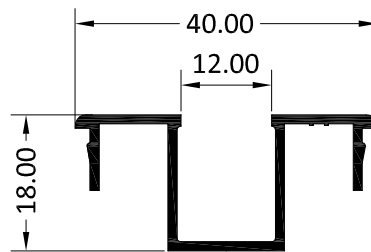

4411
LAMA FIJA

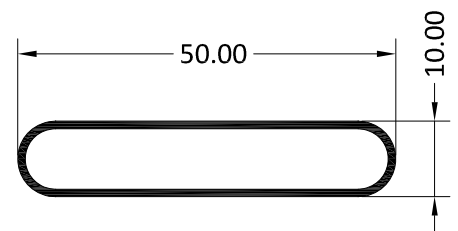

4412
LAMA MÓVIL 71 MM

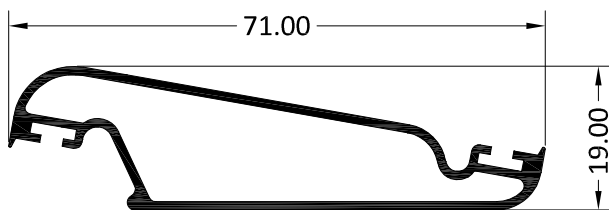

8009
LAMA MÓVIL 60 MM

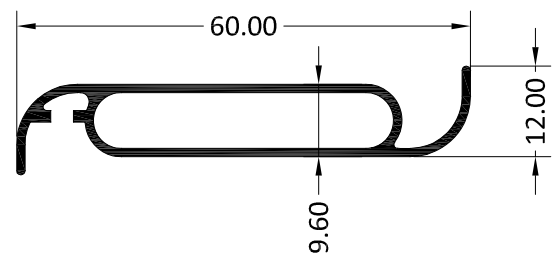

8028
LAMA MÓVIL 65.80 MM

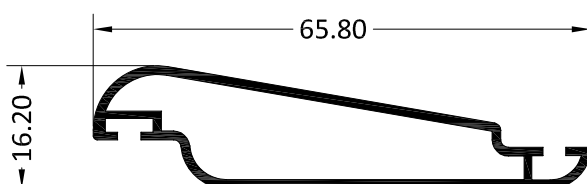

3660
LAMA PARA CELOSÍA

