



























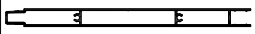

1. RELACION DE PERFILES

Sección	Referencia	Denominación	Peso (kg)	Perímetro (m)
	543	Lama de 120	0,909	0,438
	3203	Terminal de persiana 60	0,389	0,248
	3206	Terminal de persiana 52	0,289	0,235
	3210	Terminal de persiana 56.10	0,359	0,257
	3212	Cortavientos de persiana 188.50	1,002	0,470
	3213	Cortavientos de persiana 159.50	0,877	0,412
	4200	Perfil mosquitera 60.50	0,394	0,259
	4201	Perfil mosquitera 40	0,278	0,190
	4217	Lama de 100.50	0,932	0,526
	4519	Lama de persiana 38	0,237	0,191
	4520	Lama de persiana 60	0,462	0,326
	4521	Terminal de persiana 55	0,451	0,307
	4522	Terminal de persiana 32	0,202	0,167
	4523	Terminal de persiana 51	0,278	0,229















1. RELACION DE PERFILES

Sección	Referencia	Denominación	Peso (kg)	Perímetro (m)
	4524	Terminal de persiana 57.50	0,418	0,289
	4560	Unión entre lamas	0,251	0,087
	4561	Lama 79.75	0,788	0,209
	4562	Zócalo	0,870	0,409
	4563	Lama 91.25	0,517	0,310
	5243	Terminal de persiana 55.70	0,329	0,241
	5630	Lama de 79.50	0,597	0,339
	6346	Lama de 120	1,102	0,622
	6435	Lama de 200	2,044	0,988
	8010	Lama de 109.70	0,664	0,408
	8015	Lama de 109	0,923	0,531
	8029	Terminal de persiana 49-44	0,297	0,225
	8033	Terminal de persiana 49-43	0,292	0,220
	8034	Lama de persiana 49.40	0,230	0,218



1. RELACION DE PERFILES

Sección	Referencia	Denominación	Peso (kg)	Perímetro (m)
	8048	Lama de 100	0,994	0,523
	8051	Lama de 90	0,848	0,473
	8126	Lama de 80	0,560	0,348
	9102	Lama de 140	1,580	0,742
	10015	Lama de forro 150	0,707	0,349
	10016	Lama de forro 100	0,491	0,253
	10017	Lama de forro 80	0,397	0,211
	10018	Lama de forro 60	0,327	0,171
	10019	Lama de forro 40	0,256	0,131
	10020	Lama de forro 20	0,186	0,091
	10131	Lama de 100	0,497	0,285
	10420	Lama de forro 151	0,587	0,368
	11275	Lama	1,015	0,575



2. PERFILES

8010
LAMA DE 109.70

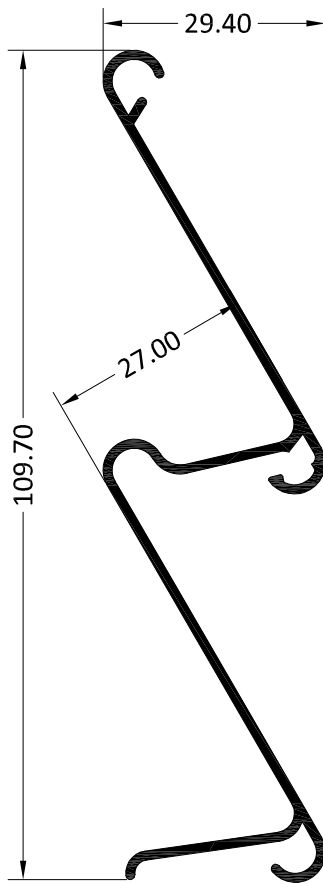

8015
LAMA DE 109

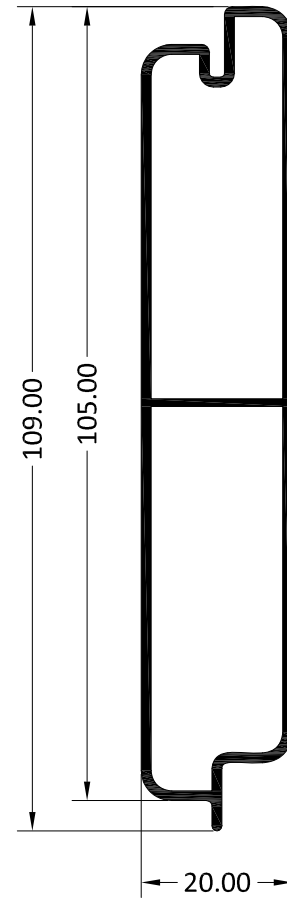

8048
LAMA DE 100

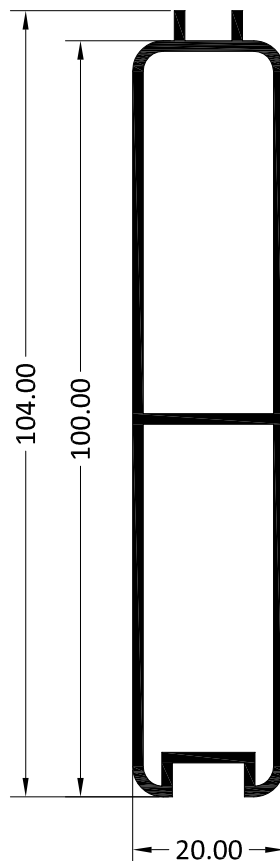

8051
LAMA DE 90

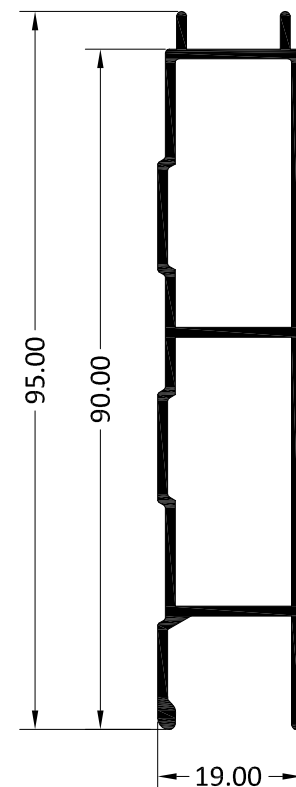



2. PERFILES

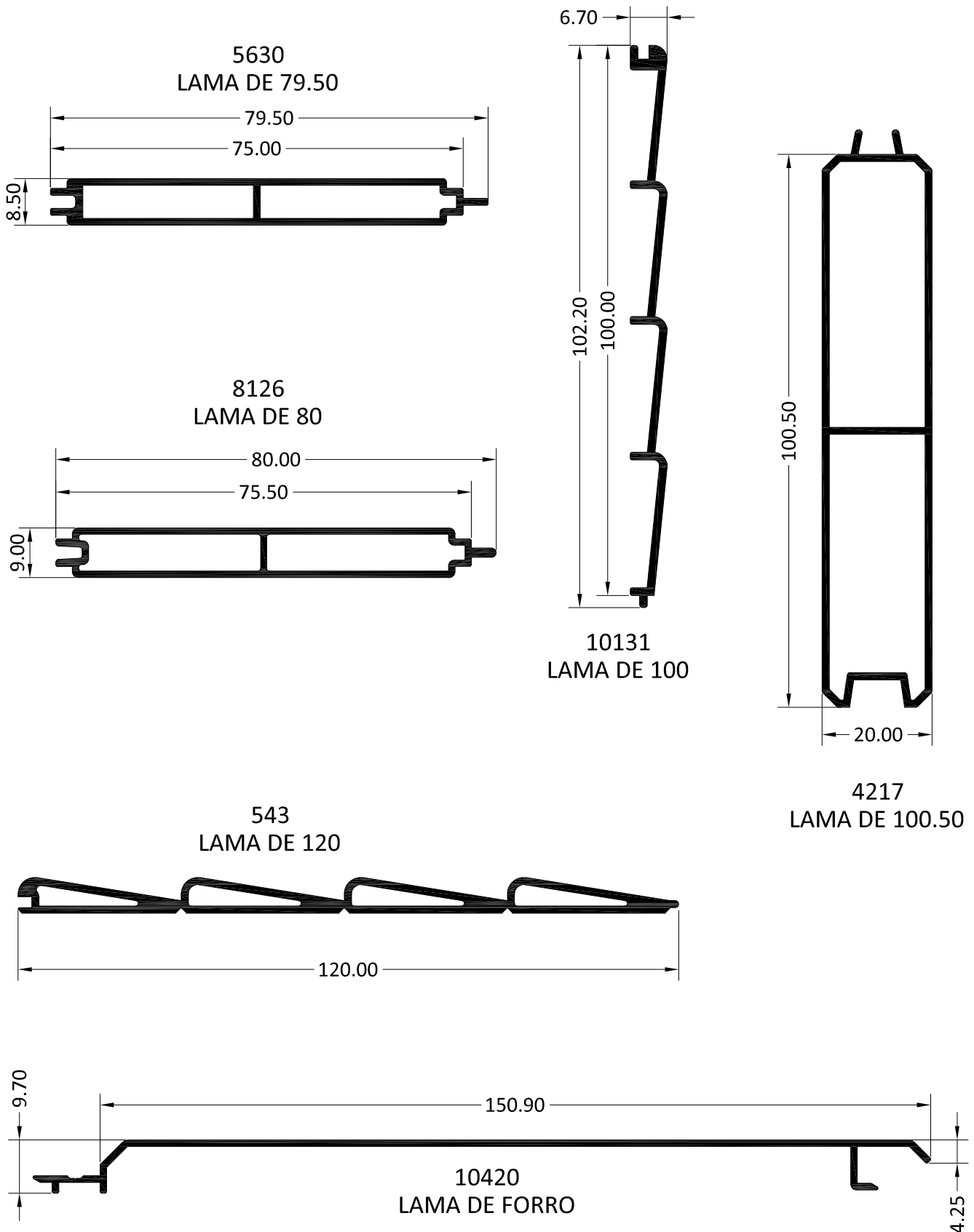

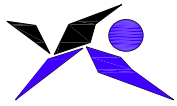

2. PERFILES

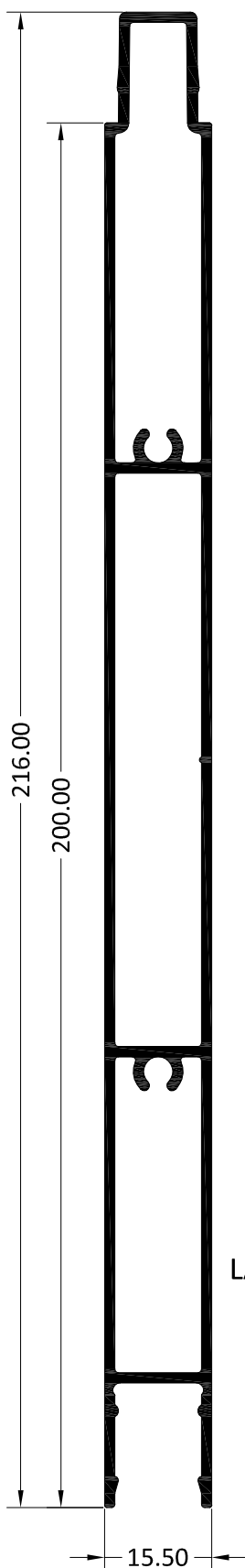

6435
LAMA DE 200

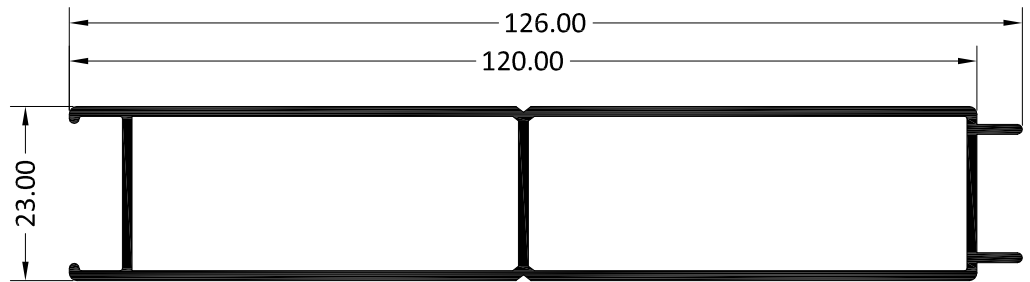

6346
LAMA DE 120

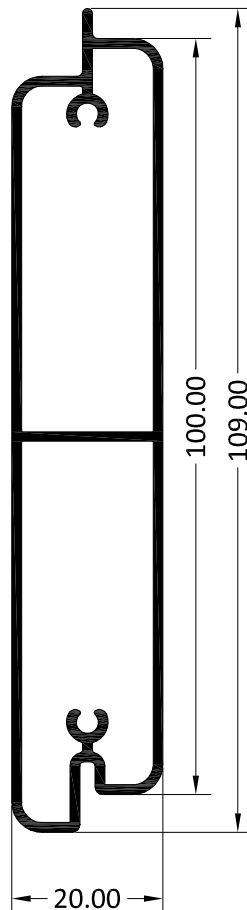

11275
LAMA DE 109

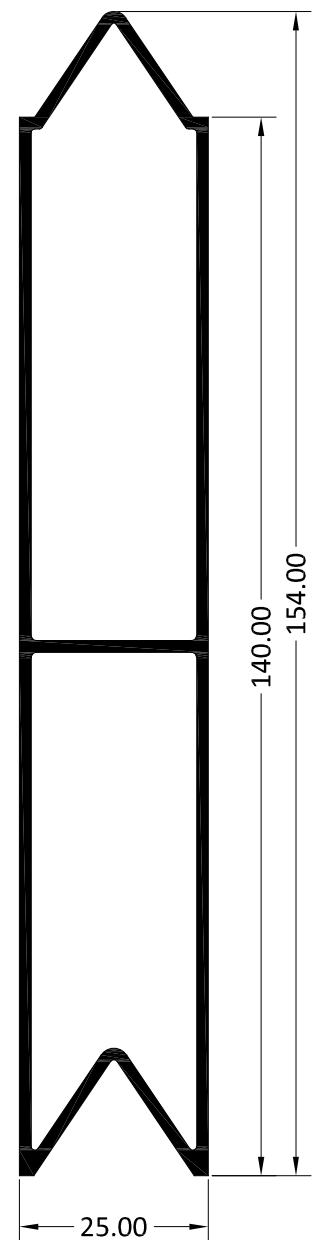

9102
LAMA DE 140



2. PERFILES

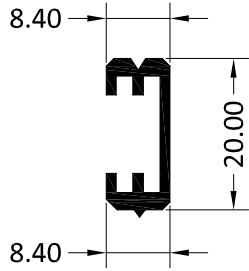

10020
LAMA DE FORRO 20

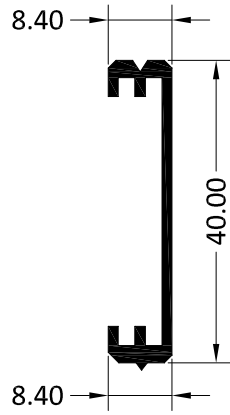

10019
LAMA DE FORRO 40

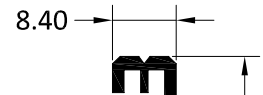

10015
LAMA DE FORRO 150

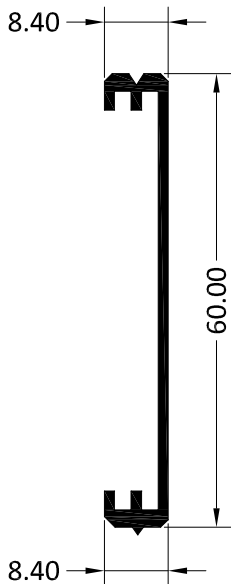

10018
LAMA DE FORRO 60

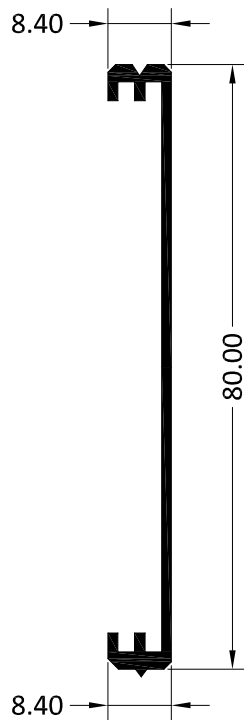

10017
LAMA DE FORRO 80

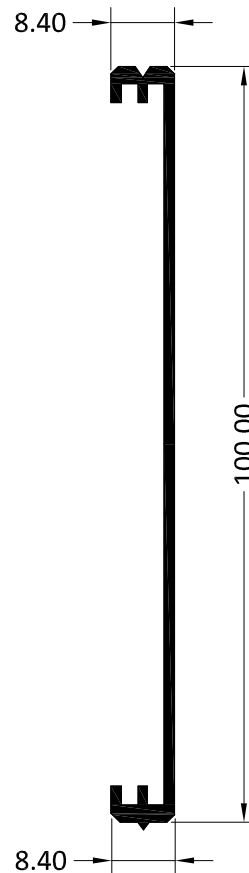

10016
LAMA DE FORRO 100

150.00

100.00



2. PERFILES

4560
UNIÓN ENTRE LAMAS

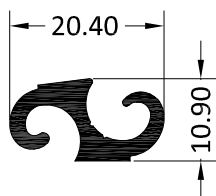

4561
LAMA DE 79.75

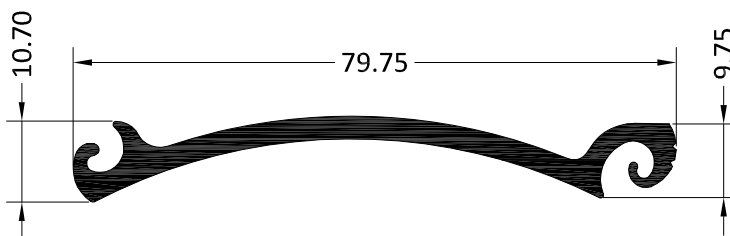

4562
ZÓCALO

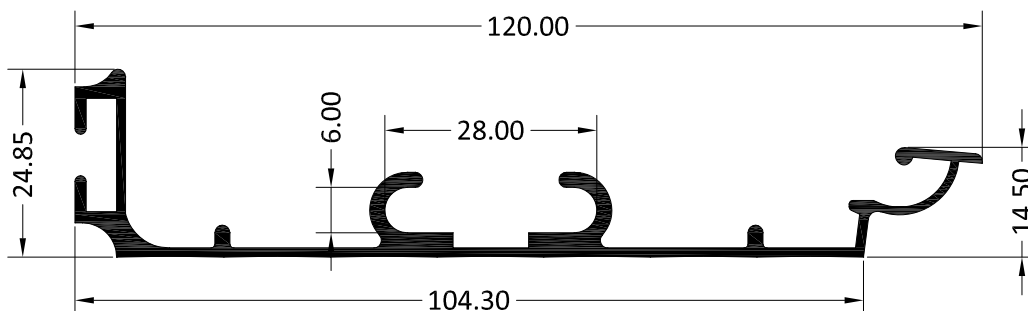

4563
LAMA DE 91.25

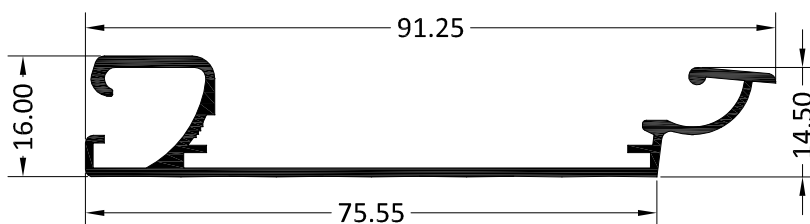



2. PERFILES

4519
LAMA DE PERSIANA
DE 38

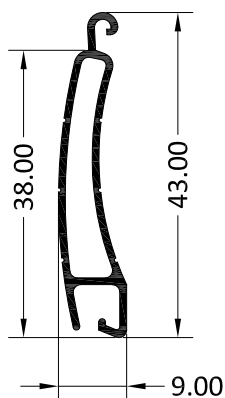

4520
LAMA DE PERSIANA
DE 60

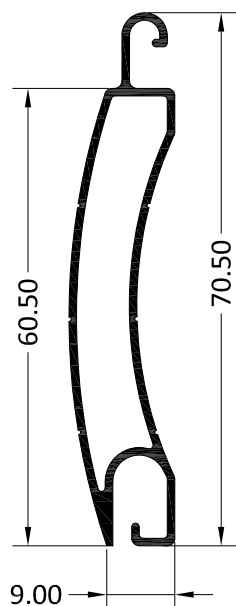

8034
LAMA DE PERSIANA
DE 49.40

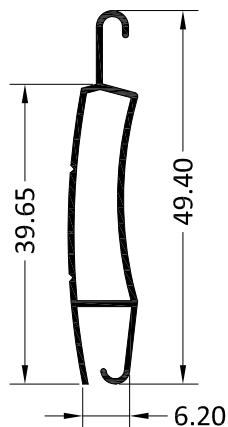

3203
TERMINAL DE
PERSIANA DE 60

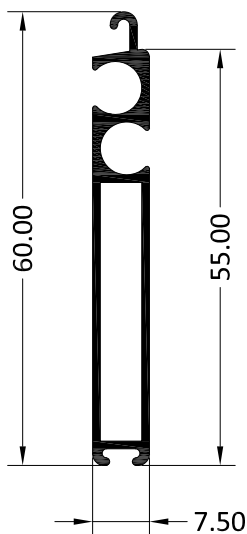

3206
TERMINAL DE
PERSIANA DE 52

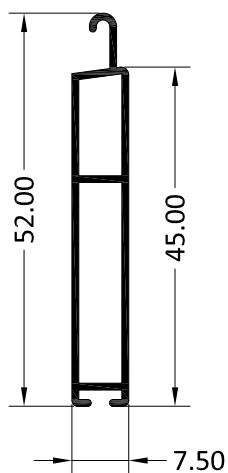

3210
TERMINAL DE
PERSIANA DE 56.10

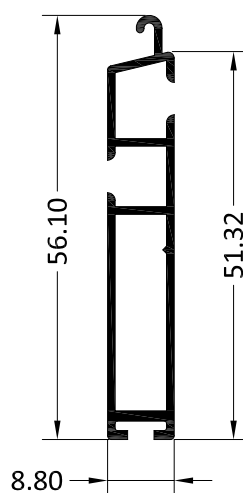

4521
TERMINAL DE
PERSIANA DE 55

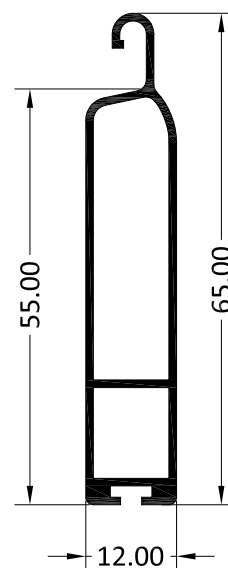



2. PERFILES

4523
TERMINAL DE
PERSIANA DE 51

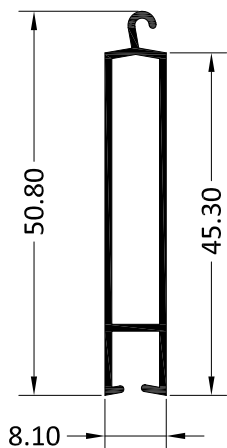

4524
TERMINAL DE
PERSIANA DE 57.50

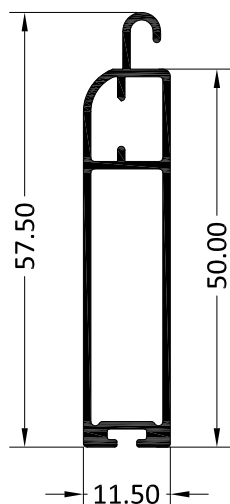

5243
TERMINAL DE
PERSIANA DE 55.70

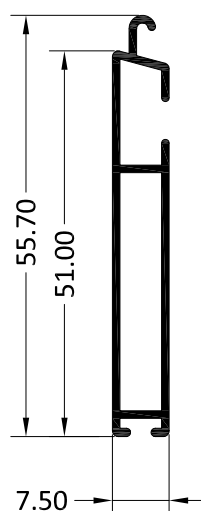

4522
TERMINAL DE
PERSIANA DE 32

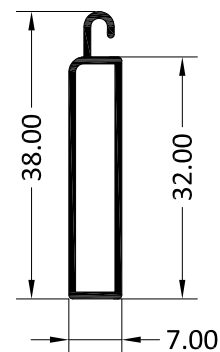

4200
PERFIL MOSQUITERA
DE 60.50

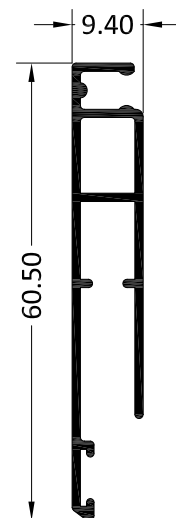

8029
TERMINAL DE
PERSIANA DE 49-44

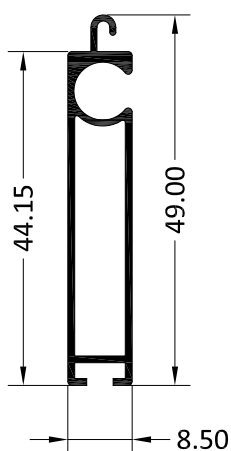

8033
TERMINAL DE
PERSIANA DE 49-43

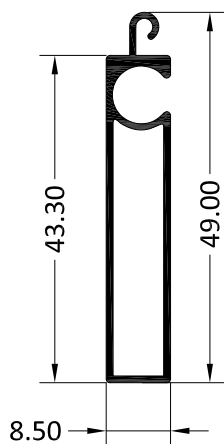

4201
PERFIL MOSQUITERA
DE 40

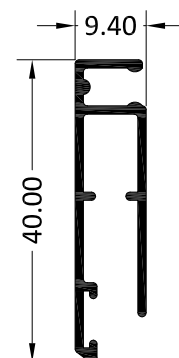



2. PERFILES

3212
CORTAVIENTOS DE PERSIANA 188.50

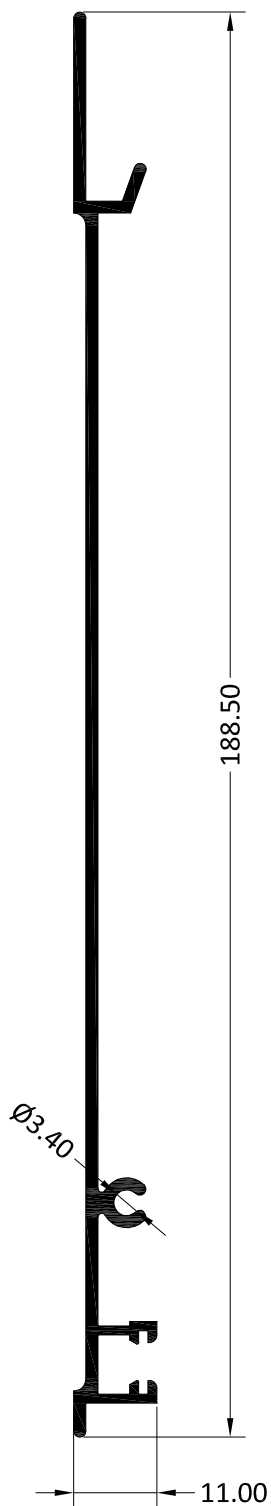

3213
CORTAVIENTOS DE PERSIANA 159.50

